

NEWS FOR THE ELECTRONICS INDUSTRY

element14

AN AVNET COMPANY

# eTECH JOURNAL

ISSUE 13

## THE POWER TO INNOVATE

POWER WITH  
IDEAL DIODES

+

OPTIMISED  
POWER,  
MINIMAL LOSS

WHERE  
GAN CAN,  
IT SHOULD...

REVOLUTIONISING  
POWER  
ELECTRONICS

POWER  
MANAGEMENT  
SOLUTIONS

# SMART INDUSTRIES – THE BRAINS BEHIND THE MACHINES

MAKING SYSTEMS SMART, SO YOU LEAD THE FUTURE  
#INNOVATELIVING

DISCOVER MORE



# SMART INDUSTRY

#INNOVATELIVING



## CONTENTS

## WELCOME



04 ROBUST POWER SOURCE WITH IDEAL DIODES

08 OPTIMIZED POWER, MINIMAL LOSS

16 WHERE GAN CAN, IT SHOULD...AND GAN CAN IN MORE AND MORE PLACES

20 REVOLUTIONIZING POWER ELECTRONICS: SiC AND GAN WIDE-BANDGAP SEMICONDUCTORS

26 POWER MANAGEMENT SOLUTIONS

Power is the silent force behind every innovation in today's connected world. From smartwatches and wearables to electric vehicles and industrial automation, effective power management is what turns concepts into real, working systems. And as devices get smaller, smarter, and more demanding, the way engineers think about power must evolve too.

Modern power design is no longer just about supplying energy, it's about delivering it with precision, intelligence, and efficiency. As system complexity grows across IoT, automotive, and industrial sectors, designers are rethinking how to generate, manage, and protect power at every level. With breakthroughs in wide-bandgap semiconductors, ultra-efficient inductors, and fast-switching ideal diodes, the future of power electronics is being redefined.

In this edition of eTechJournal, we explore the theme **"Power to Innovate: Smarter, Smaller, Stronger."** Learn how to design robust power paths with minimal losses, maximize energy density in tight spaces, and harness the full potential of GaN and SiC technologies. Whether you're engineering the next-gen health monitor or pushing the limits of high-frequency conversion, this issue is packed with insights to power your designs forward.

Let's reimagine what's possible - one volt at a time.



**Cliff Ortmeier** Editor, eTech Journal  
Email: editor-TJ@element14.com



To register for all future editions and to access all back issues of eTech Journal, scan QR code

Editor-in-chief: Cliff Ortmeier, Managing Editor: Ankur Tomar

©Premier Farnell. All rights reserved. No portion of this publication, whether in whole or in part, can be reproduced without the express written consent of Premier Farnell. All other registered and/or unregistered trademarks displayed in this publication constitute the intellectual property of their respective holders. Errors and omissions in the printing of this magazine shall not be the responsibility of Premier Farnell. Premier Farnell reserves the right to make such corrections as may be necessary to the prices contained herein.



VISIT ANALOG DEVICES

# ROBUST POWER SOURCE WITH IDEAL DIODES

Frederik Dostal, Power Management Expert

Robust systems often allow multiple power sources. When different power sources are used to power a device, switches need to be implemented to separate the power supplies from each other to avoid damage. This can be accomplished with multiple diodes in the power path. However, a more flexible and much more efficient way is to use ideal diodes for this task. This article explains how such ideal diodes are beneficial. Two versions of ideal diodes are shown: one where the selection of input rail is independent of the voltage level, and a simpler one where the higher voltage always powers the system.



There are many applications that can be supplied with several different voltage sources. In addition to a primary energy source, battery-operated devices are often equipped with the option of using a plug-in power supply as an alternative. It is also common to supply power with a wall wart AC-to-DC converter as an additional energy source to a primary power supply via a USB cable. A variety of the energy supply of a device is not only beneficial for the user, but also enables increased robustness through energy source redundancy.

The use of different voltage sources requires a higher effort regarding circuit design. It is often necessary to ensure that one energy source does not flow backward into another energy source and possibly cause damage as a result. Figure 1 shows a simple setup to protect the respective unused voltage source.

Diodes are used in the power path. This works reliably but has one major limitation. In such a setup, the energy source with the higher voltage is always used to power the load. The diodes also show a voltage drop of 150 mV to 450 mV in the power path, which generates a high power dissipation, especially at low voltages.

With battery-powered devices, this increased power loss is unfavorable. To circumvent the disadvantages mentioned, ideal diodes are suitable. The term ideal diode refers to components that use a switch (usually a MOSFET) instead of a diode. In its switched-on state, an ideal diode has a much lower drop voltage. This voltage drop is based on the actual current flow through the switch and depends on the switch's on-resistance (RDS(ON)).

Figure 2 shows a circuit with two ideal diodes executed with two LT4422 devices. These integrated circuits have a low voltage drop due to the low resistance in the power path of only 50 mΩ. The IC's own power consumption is only 10 μA, further keeping the total losses low. Figure 2 shows an additional function. An LED can be added as an indicator for which voltage source is powering the load at any given time. The circuit in Figure 2 is therefore a replacement for the circuit in Figure 1, with a lower power dissipation and extended features, such as the LED indicator.

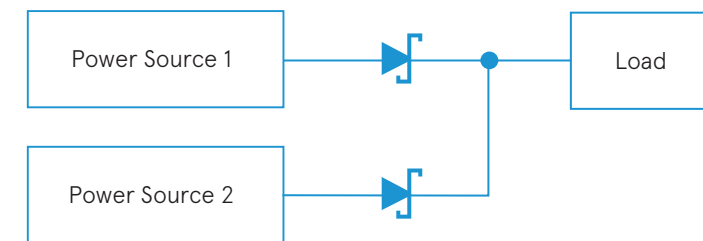

Figure 1 - Two power sources with diodes in the power path to power an application

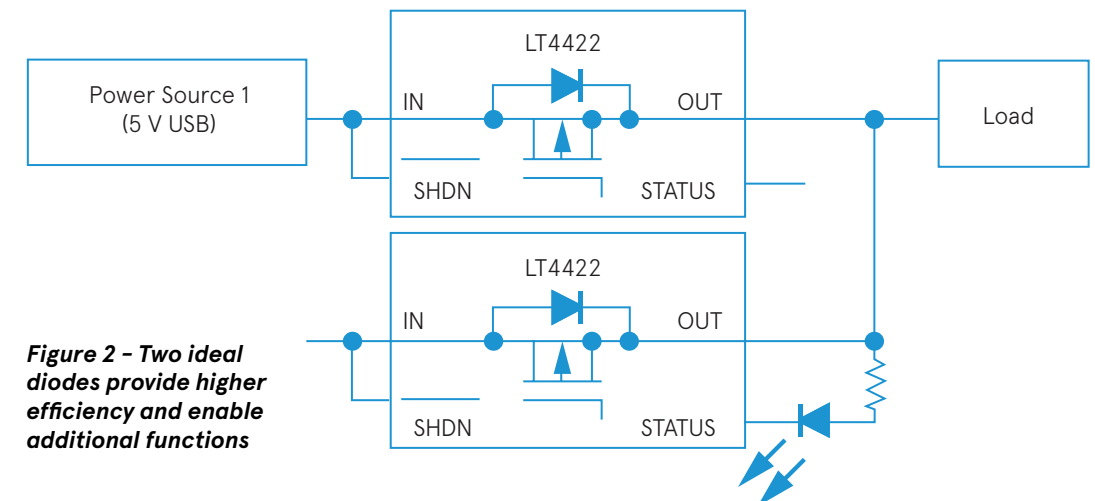

Figure 2 - Two ideal diodes provide higher efficiency and enable additional functions

However, one feature has remained the same in the circuit in Figure 2. The voltage source with the higher value supplies the device with power. The ideal diode (LT4422) has an enable pin (SHDN), but the body diode of the built-in MOSFET becomes conductive when the IN voltage is higher than the OUT voltage. To prevent this, there is a derivative of the LT4422, the LT4423, which uses two MOSFETs in the power path back to back. These are arranged in such a way that the respective body diodes will not allow a current flow if the other MOSFET is not switched on at the same time.

Figure 3 shows a circuit design in which the supply voltage can be freely determined for supplying the load with energy. The behavior is therefore independent of the respective level of the supply voltage. However, since two integrated MOSFETs are required, the resistance in the power path increases from 50 mΩ (LT4422) to 200 mΩ (LT4423) when switched on.

Finally, the version with the two MOSFETs (LT4423) also offers the function of an integrated thermal shutdown.

In contrast to a conventional diode, this ideal diode switches off when the component heats up above 160°C (typically). This feature can create an even more robust system.

Ideal diodes not only help to allow different power supply options for a device, but they also enable greater robustness through implemented redundancy. In addition, ideal diodes offer features such as detection of the supply status with an LED and protection shutdown in the event of excessive temperatures.

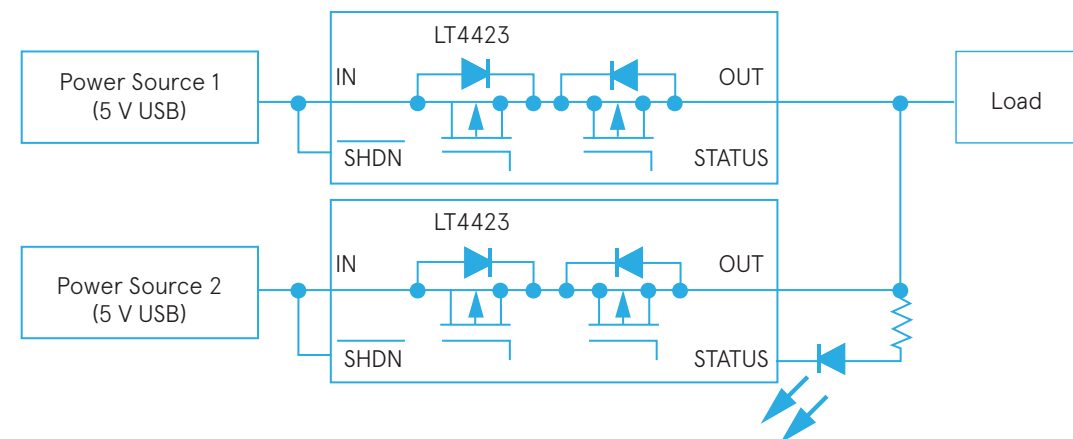

**Figure 3 - Two ideal diodes with power source selection independent of the respective value of the voltage sources.**

## ABOUT THE AUTHOR

Frederik Dostal is a power management expert with more than 20 years of experience in this industry. After his studies of microelectronics at the University of Erlangen, Germany, he joined National Semiconductor in 2001, where he worked as a field applications engineer, gaining experience in implementing power management solutions in customer projects. During his time at National, he also spent four years in Phoenix, Arizona (U.S.A.), working on switch-mode power supplies as an applications engineer. In 2009, he joined Analog Devices, where he has since held a variety of positions working for the product line and European technical support, and currently brings his broad design and application knowledge as a power management expert. Frederik works in the ADI office in Munich, Germany.

## CONCLUSION

Ideal diodes are useful replacements for regular diodes to increase the power efficiency in systems with multiple power sources. Besides the reduction of power losses, such ideal diodes also offer flexibility along with additional features. They are easy to use and simple to design with. This is especially true when devices with a high integration are used, such as the LT4422 and LT4423.

[CLICK HERE](#)

# OPTIMIZED POWER, MINIMAL LOSS

## Compact, Self-Shielding Storage Inductors for Maximum Efficiency

A newly developed series of compact inductors combines the best possible power density and current handling capability with low losses, thanks to intelligent material selection and manufacturing technology. The REDEXPERT online design platform supports realistic simulation and selection processes.

Energy-efficient devices are essential for conserving resources and protecting the environment. The more efficient the electronics, the longer the battery life of mobile devices, and the lower the energy consumption in large industrial and server systems.

The power supply has a significant impact based on energy efficient devices. While linear regulators were the most used voltage regulators in the past, modern power electronic circuits now use switching power supplies. The continuous reduction of processor voltages has contributed to this shift. A few years ago, switching frequencies of up to 300 kHz were common, but today, modern switching regulators based on GaN and SiC transistors typically operate at frequencies in the MHz range.

Switching losses on the one hand, and storage inductor losses in particular at this high frequency range on the other, are critical aspects in the design of switching power supplies [1].

In addition to energy efficiency, rising energy demand is becoming increasingly important. Computers are becoming more powerful, which in turn requires more powerful power supplies. This means that switching power supplies have to deliver higher currents, which in turn means that power inductors have to have a much higher current handling capacity. Achieving this capability is further complicated by the additional trend towards miniaturisation. Switching power supplies must become smaller and more compact while still delivering the same or even higher power in a smaller volume. This increases the demands on the power density of the inductor.

To meet these requirements, new material blends of iron alloys are continuously being researched to further reduce core material losses in high-current storage inductors. This has led to the development of the new WE-MXGI series, which combines the best possible power density and current handling capability with the lowest RDC and minimal self-losses thanks to intelligent material selection and manufacturing technology.

Power supply designers are supported by the online design platform REDEXPERT [2], which allows the determination of DC and AC losses of storage inductors with unprecedented accuracy. This is achieved through a measurement-based process that allows core losses to be calculated much more accurately than would be possible using the Steinmetz formulas.

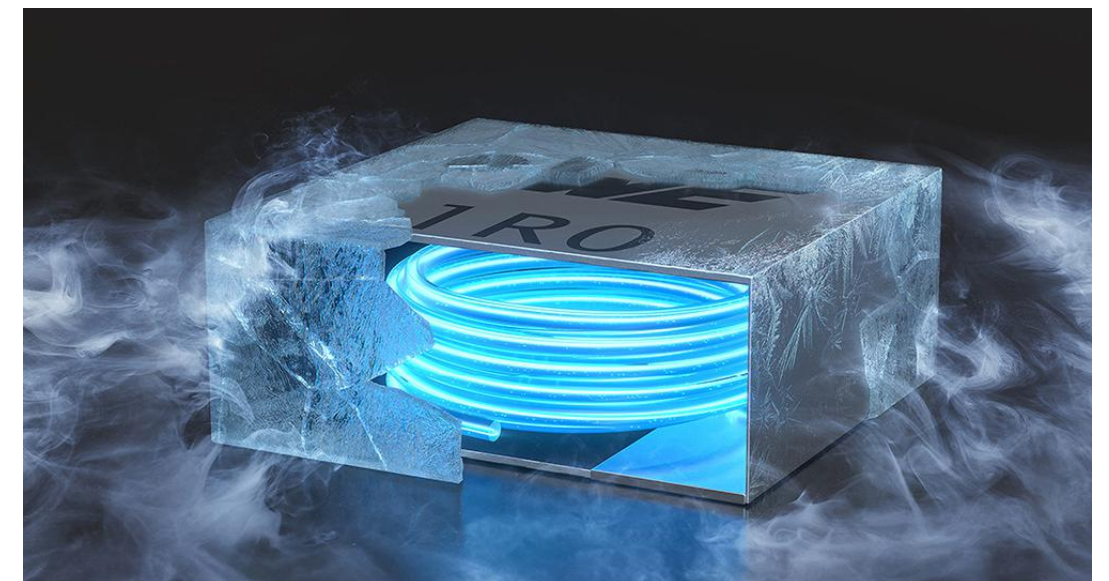

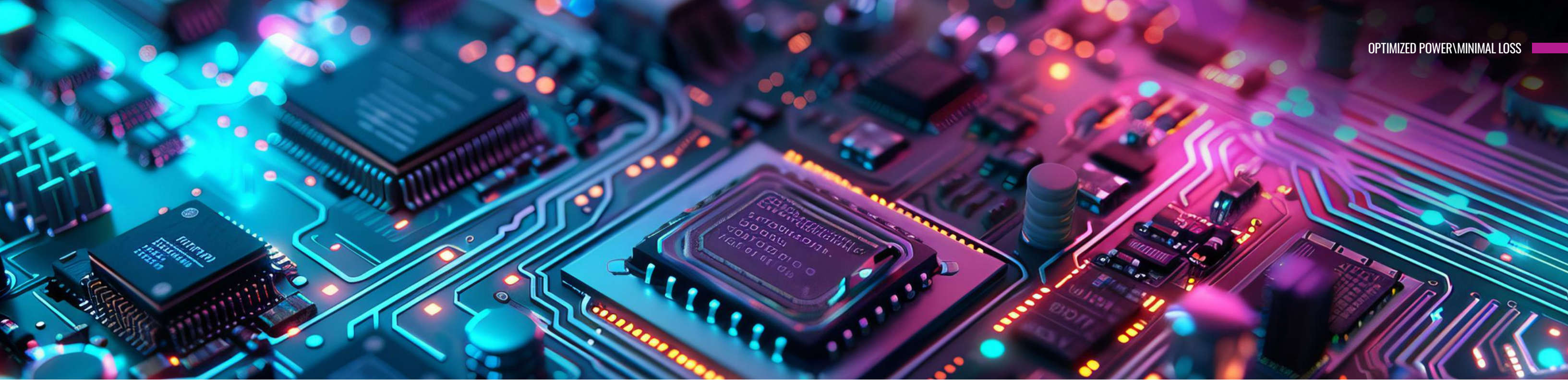

## OVERVIEW OF THE WE-MXGI STORAGE INDUCTOR

The WE-MXGI storage inductor is Würth Elektronik's latest and most innovative coil series. In conventional ferrite chokes, the copper wire is typically wound around the core and soldered or welded to the terminal. The outer shielding ring is then assembled and bonded with the inner core and winding. The WE-MXGI belongs to the group of molded storage inductors. The core powder consists of an innovative iron alloy that, unlike a ferrite choke, is molded around the winding. This gives the WE-MXGI high inductance values in a small form factor. The unique core construction also provides a self-shielding effect.

The core material itself is temperature-stable, showing no signs of thermal aging, with soft saturation behavior and minimal saturation drift over a wide temperature range. It also has a high dielectric strength, enabling an operating voltage specification of 80 V. An explanation of how Würth Elektronik defines the operating voltage can be found in Application Note ANP126 [3]. To make the core resistant to environmental influences and the formation of rust, an additional protective layer is applied to the surface.

Most molded inductors on the market still contain a clip to which the winding is welded. In contrast, the WE-MXGI uses a direct contact method, eliminating soldering and welding processes by connecting the winding directly to the component's connection pads. By eliminating the clip, the space within the core material is optimized, allowing for a larger coil diameter and the use of thicker copper wire. This results in a significantly reduced DC resistance (RDC) of the winding (Figure 1).

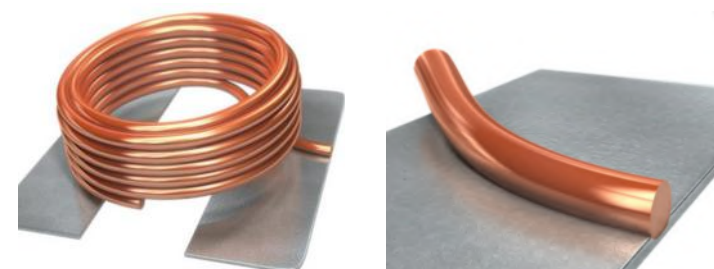
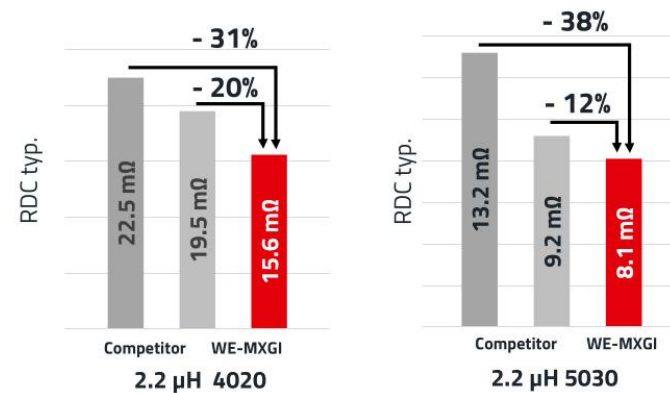

Figure 1 - The direct contact method of the WE-MXGI enables low  $R_{DC}$  values



In applications, the start of the coil winding is usually connected to the switching node of the switching regulator and the component is marked accordingly. This reduces coupling effects and disturbances from the switching node, which are shielded by the winding. The optimized wire geometry of the WE-MXGI, based on round wire, makes this shielding effect possible. Products based on flat wire commonly found in the market do not have this effect (Figure 2) [4].

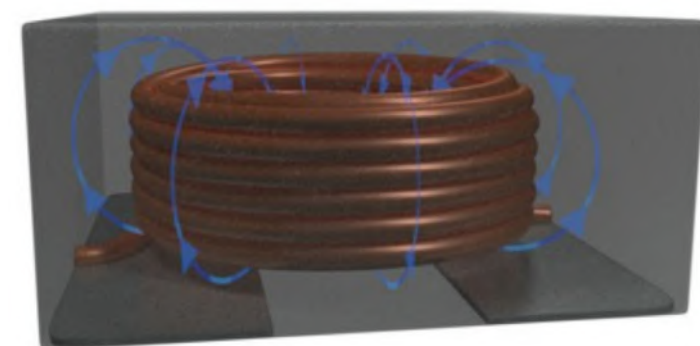

Figure 2 - A self-shielding winding and core construction ensure improved EMC performance

The new WE-MXGI series is currently available in sizes 4 x 4 x 2 mm<sup>3</sup> and 5 x 5 x 3 mm<sup>3</sup>, with continuous expansion planned (Figure 3).

Figure 3 - Overview of the available designs and excerpt from the 27 products of the WE-MXGI storage choke, which are currently being expanded.

### Products

- All
- 4020
- 5030

Order Code	Data-sheet	Simulation	Downloads	L (µH)	I <sub>RP,40K</sub> (A)	I <sub>SAT,30%</sub> (A)	R <sub>DC typ.</sub> (mΩ)	f <sub>res</sub> (MHz)	V <sub>OP</sub> (V)
74438440200016	<a href="#">SPEC</a>	<a href="#">RE</a>	5 FILES	0.16	24.2	27.9	1.5	197	80
74438450300022	<a href="#">SPEC</a>	<a href="#">RE</a>	5 FILES	0.22	28.1	25.4	1.5	155	80
7443844020010	<a href="#">SPEC</a>	<a href="#">RE</a>	5 FILES	1	12.1	9.8	6.9	59	80
7443845030022	<a href="#">SPEC</a>	<a href="#">RE</a>	5 FILES	2.2	12.4	10.5	8.1	35	80
7443844020022	<a href="#">SPEC</a>	<a href="#">RE</a>	5 FILES	2.2	7.8	5.8	15.6	37	80
7443845030033	<a href="#">SPEC</a>	<a href="#">RE</a>	5 FILES	3.3	10	8.2	12.9	25	80
7443844020047	<a href="#">SPEC</a>	<a href="#">RE</a>	5 FILES	4.7	5.2	5.7	40.3	25	80
7443845030100	<a href="#">SPEC</a>	<a href="#">RE</a>	5 FILES	10	5.5	5.4	41.5	12	80

## LOSSES IN STORAGE INDUCTORS

The losses in a storage inductor consist of core material losses and winding losses. The loss mechanisms are described in detail in Würth Elektronik's Application Note ANP031 [1], and are summarised below. Winding losses can be divided into DC losses, primarily influenced by the DC resistance RDC of the winding (Equation 1), and AC winding losses, which result from the skin and proximity effects.

$$P = I^2 R_{DC}$$

There are several methods for determining the AC losses of the winding- for example, the Dowell, Ferreira, or Nan/Sullivan methods.

The significance of losses in modern switching regulators can be determined with a simple setup and measurement of the corresponding losses. For example, a buck converter with an input voltage of 24 V is used. The output provides a voltage of 6 V at a current of 8 A. The switching frequency is 1 MHz. In the comparison shown in Figure 4, a 2.2 µH inductor from the WE-MXGI 5030 series was measured and compared with a similarly sized inductor. It is clear that both the AC losses and DC losses of the WE-MXGI are lower than those of the competing products.

The coil is one of the most important components in a switching regulator. Therefore, accurate determination of losses and temperature rise is a critical step in selecting the right component.

To predict temperature rise, AC losses must first be accurately determined.

One approach is the Steinmetz models, which provide an acceptable approximation, particularly for sinusoidal excitations and a 50% duty cycle. However, the Würth Elektronik model provides more accurate results.

The AC loss calculator in REDEXPERT [2] includes a model to accurately determine the total AC losses in inductors. This model is based on empirical data obtained from a real-time application setup where the total losses of the inductor are divided into AC and DC losses.

The empirical data is collected using a DC/DC converter. A pulsating voltage is applied to the inductor, with input power Pin and output power Pout measured. This is used to calculate Ploss = Pin - Pout. The system losses, the DC losses and the AC losses of the inductor PAC are then separated. This process is measured for various parameter settings - such as variations in magnetic flux, switching frequency, ripple current, etc. - with all the data recorded. The empirical data is then used to create a model for calculating the AC losses as a function of the test conditions (Equation 2).

$$P_{AC} = f(\Delta I, \text{freq}, DC, k1, k2)$$

### Advantages of the Würth Elektronik AC Loss Model:

- Empirical data is based on a DC/DC converter
- Accurate determination of losses for any given duty cycle
- Accurate over a wide frequency range (10 kHz to 10 MHz)
- Considers even the smallest changes in core material and winding structure
- Applicable to components with more than one material
- Accurate determination of losses in components with iron powder and metal alloys
- Valid for any core shape and winding structure
- Includes AC winding losses

The Würth Elektronik model has been extensively validated and compared with existing models and measured data. AC losses for various materials such as WE-Superflux, iron powder, NiZn, MnZn, etc., have been measured over large duty cycle and frequency ranges and compared with theoretical models (Figure 5). The diagrams show the core losses determined by the Steinmetz power equation (Pst), Modified Steinmetz Equation (Pmse), and Generalized Steinmetz Equation (Pgse). In "REDEXPERT" the AC loss is marked after calculation with the Würth Elektronik AC loss model. "Real" represents the measured AC loss.



Figure 4 - AC and DC loss components of a 2.2 µH coil (WE-MXGI) in a buck converter with 24 V input, 6 V output, 8 A output current, and a switching frequency of 1 MHz, compared to another coil.

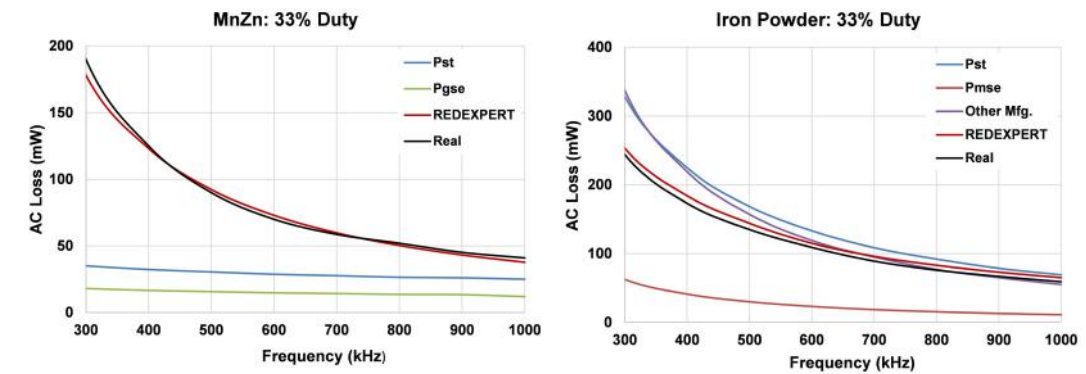

Figure 5 - AC losses in MnZn and iron powder core materials at a 33% duty cycle, as calculated by various Steinmetz models, simulated with REDEXPERT, and measured in reality.

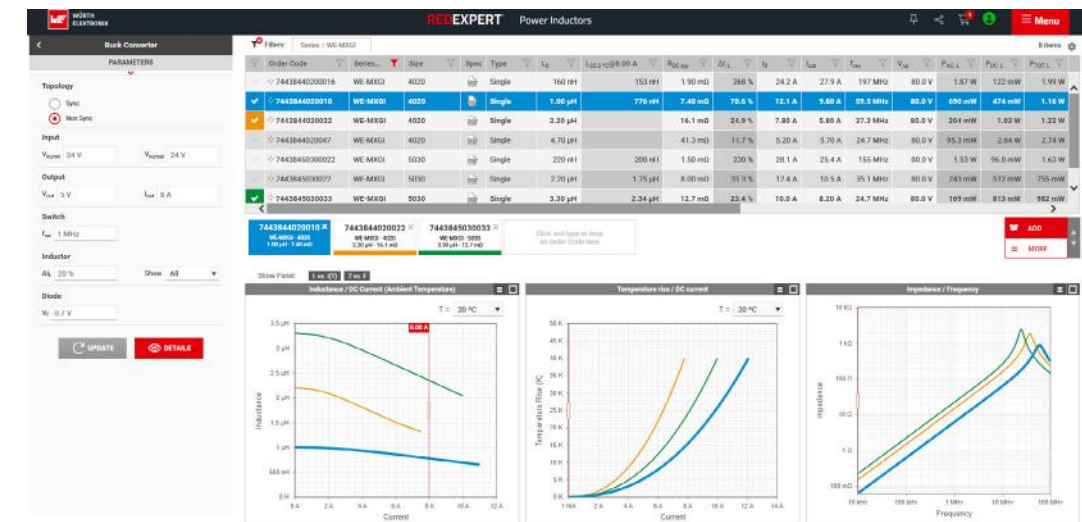

Figure 6 - Simulation of a DC/DC buck converter in REDEXPERT using WE-MXGI components

## SELECTING WE-MXGI WITH REDEXPERT

The WE-MXGI storage inductors, with their innovative core material and thoughtful design, are optimized for maximum power and efficiency in the smallest possible space, making them ideal for modern switching converters. For energy-efficient switching regulators, best way to select the right WE-MXGI storage inductor is to use REDEXPERT (Figure 6), Würth Elektronik's online design platform. It incorporates the world's most accurate AC loss model, achieving very high accuracy over a wide range of parameters such as frequency, ripple current, and duty cycle. In addition, REDEXPERT suggests suitable products once the required parameters of a customer application have been entered.

Würth Elektronik's current rating calculator, now also available in REDEXPERT [5], helps with selecting the appropriate product. This includes a thermal model of each inductor, also based on measurement data, to determine the rated current depending on PCB dimensions. An explanation of the thermal behavior of power chokes can be found in Application Note ANP096 [6].

## ABOUT THE AUTHOR

**Theo Ritzmann** completed his bachelor's degree in electrical engineering at Heilbronn University of Applied Sciences. He has been working in product management at Würth Elektronik eiSos in the Power Magnetics division since 2017. Initially in the role of a Product Manager and since 2022 in the position of Technical Lead. His core competencies include the development and release of molded inductors. He is also currently involved in research in the field of metal alloy materials with regard to operating voltage and thermal ageing.

## REFERENCES

[1] Gerfer, A.; Brahmanpalli, R.; Baier, J.: Determination of the Ideal Power Inductor for Energy-efficient Applications. Application Note ANP031 from Würth Elektronik: [www.we-online.com/ANP031](http://www.we-online.com/ANP031)

[2] Online-Design-Plattform REDEXPERT from Würth Elektronik: <https://redexpert.we-online.com/we-redexpert/en/#/home>

[3] Frankemölle, A.; Lang, A.: Voltage specification for molded inductors. Application Note ANP126 from Würth Elektronik: [www.we-online.com/ANP126](http://www.we-online.com/ANP126)

[4] Bramanpalli, R.: The Behavior of Electro-Magnetic Radiation of Power Inductors in Power Management. Application Note ANP047 von Würth Elektronik: [www.we-online.com/ANP047](http://www.we-online.com/ANP047)

[5] Blakey, R.: Rated Current Calculator. Application Note ANP138 from Würth Elektronik: [www.we-online.com/ANP138](http://www.we-online.com/ANP138)

[5] Blakey, R., Gerfer, A.: What do rated current values mean? Application Note ANP096 from Würth Elektronik: [www.we-online.com/ANP096](http://www.we-online.com/ANP096)

## CONCLUSION

The WE-MXGI storage inductor series from Würth Elektronik sets a new standard for energy-efficient power electronics, offering unmatched power density, low losses, and self-shielding in a compact design. With REDEXPERT's precise AC loss modeling, designers can optimize modern switching regulators for maximum efficiency. Discover the WE-MXGI series and explore advanced design tools at Farnell.

[CLICK HERE](#)

WÜRTH ELEKTRONIK MORE THAN YOU EXPECT

# ULTRA LOW LOSSES

## WE-MXGI

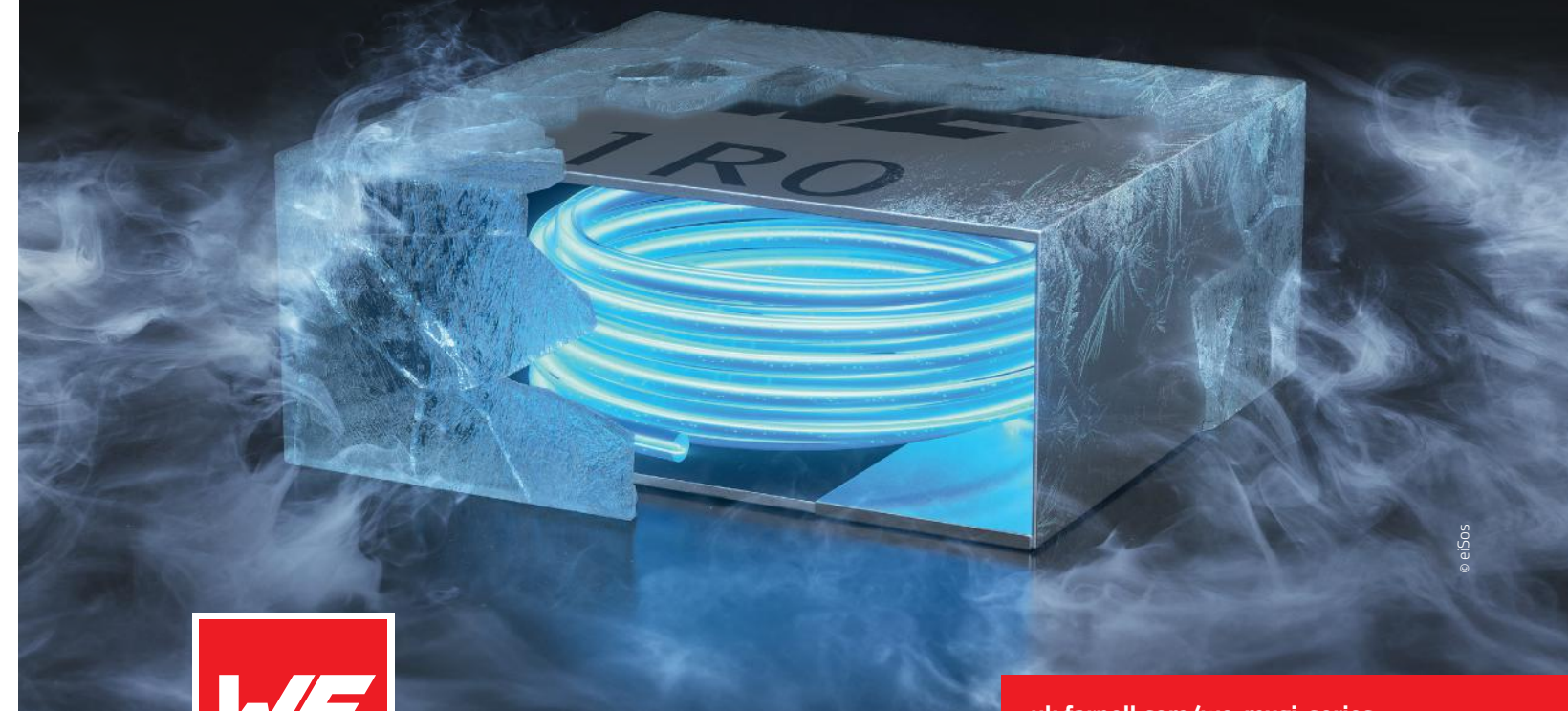

[uk.farnell.com/we-mxgi-series](http://uk.farnell.com/we-mxgi-series)

With the WE-MXGI Würth Elektronik offers the newest molded power inductor series. It combines an innovative iron alloy material that provides high permeability for lowest  $R_{DC}$  values combined with an optimized wire geometry.

Ready to Design-In?  
Click here so see the range at Farnell:  
[uk.farnell.com/we-mxgi-series](http://uk.farnell.com/we-mxgi-series)

#UltraLowLosses

### Highlights

- Extremely high power density
- Ultra low  $R_{DC}$  values and AC losses
- Magnetically shielded
- Optimized for high switching frequencies beyond 1 MHz



VISIT POWER INTEGRATIONS

# WHERE GAN CAN, IT SHOULD...

SiC v GaN v SJ MOSFETs v IGBTs? Each has its place and that's why we, at Power Integrations, do not treat GaN as a market, it's a technology. It's just one of many in our armory, along with SiC and various different MOSFET technologies and we use what we determine to be the most appropriate, application by application.

## INTRODUCTION

The perception of GaN's place has changed significantly with our recent, dramatic - and I think that is a justifiable adjective to use - launch of a GaN device with a breakdown voltage of 1700 V.

Let's put that into perspective: 1700 Vs 450 V higher than our previous best, and 70% higher than the best offered by any other maker (which, incidentally, we believe is currently not available as a shippable high-volume product).

Most GaN companies are struggling to get much above 750 V. We launched a flyback power supply IC, InnoMux™-2 that is rated at 1700 V, so can easily cope with 1000 VDC rail applications. It is available to order with 16 weeks delivery leadtime in volume, and samples are available off the shelf.



**What does this mean for industry and the whole 'GaN v SiC, which power IC technology is best' discussion?**

In short, we believe that GaN will soon be able to address all application sectors from the low !Os of watts up to 100s to kilowatts.

Let's break it down. GaN has already won the low power charger market from 30 W to, say, 240 W. This is because it is much more efficient than super junction MOSFETs, featuring negligible switching losses and very low specific RDSon. Therefore, higher power densities are achievable, devices can be made smaller or more powerful, and the thermal management challenge is much reduced. And although MOSFETs are currently cheaper than GaN HEM Ts, the need for advanced, resonant topologies and heatsinks makes them less cost effective than GaN at the system level.

This GaN advantage will only improve as economies of scale kick in and production ramps up. The only reason why MOSFETs may be preferred for very low power applications (for example <20 W) is that the GaN die at low power levels are so small they are hard to handle.

As we move up in power levels through 500 W, 1 kW and up to 10kW. GaN is also winning. Here we are looking at applications such as refrigerators, e-bike chargers, washing machines and other white goods, HVAC compressors, solar, certain automotive functions such as the on-board charger and lead-acid replacement battery circuits, and server PSUs. All these are transitioning from MOSFETs. Some have already made the move to SiC, and since SiC and GaN have comparable efficiency ratings, why should GaN prevail here? Simply, the reason is cost. SiC requires huge amounts of energy to create the high processing temperatures required. GaN does not.

A GaN device is inherently no more expensive to produce than a silicon part- devices can even be made on the same production lines with relatively few modifications.

More and more of these 1 to 10kW applications - previously the preserve of MOSFETs and SiC - will be addressable by GaN, and it won't stop there. Currently, GaN tops out at around 7-10 kW.

That's a little short of satisfying the needs of the EV inverter market - the biggest single power IC application TAM - but you only need another factor of 10 to get to EV power levels of a few 100 kW, and a factor of 10 in high tech is a matter of just a few years. There's no substantive constraint, there's no physical limitation ... it's not invention or inspiration that is needed, it's development.

At the very high power end of the scale - multi-megawatt wind turbines and gigawatt high-voltage DC installations - IGBTs are well-established and comparatively cheap.

Therefore, SiC looks set to be squeezed into a relatively small section of the market, which needs the higher currents that the vertical technology can offer.

One final point. When any new technology comes along, or takes a significant step forward, the first thing it does is directly replace the previous tech. But then someone bright comes along and says, 'well that's OK, but the new tech allows us to completely rethink the design - to come up with a new concept that makes best use of the new technology without referring back to what was required by the old'. We're continuing to innovate at the microelectronics, packaging, system, and algorithm levels to develop application-specific power products that roll the rock forward in efficiency, cost effectiveness and component count, opening up new ideas for new markets.

**The Best Switch Technology**

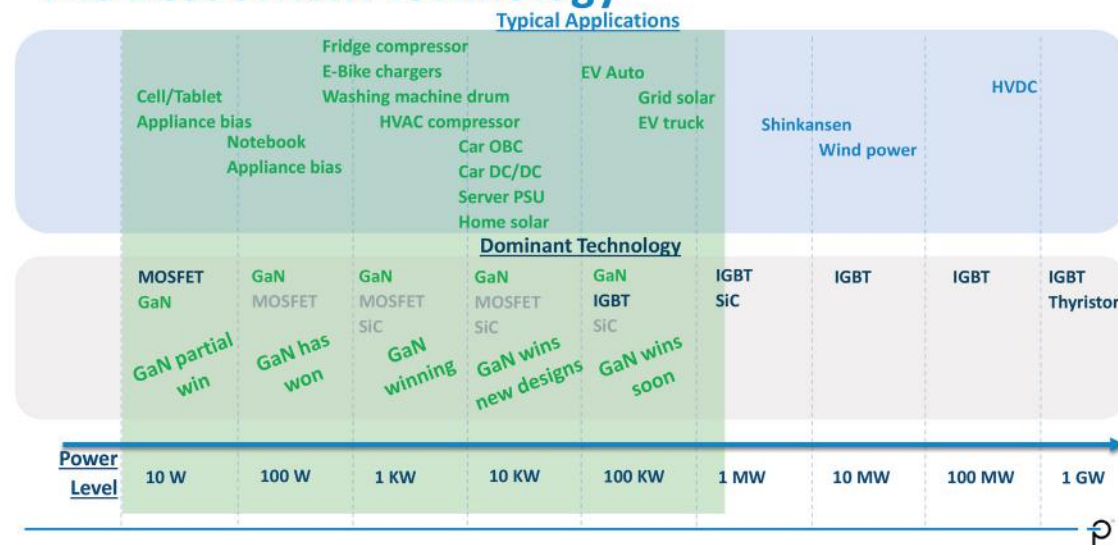

**NEW! POWIGAN™ INNOMUX™-2 1700V GAN SWITCHER**

World's First 1700V GaN Power Device. Delivers >90% efficiency from a 1000 VDC bus, supplying up to 60 W with three precisely regulated outputs.



**USB Type-C Power Delivery Controller**

[BUY NOW](#)



**Wall Outlet & Power Strip with USB Ports**

[BUY NOW](#)



**RDK-838 USB Power Delivery Controller**

[BUY NOW](#)



**RDK-802 Power Supply**

[BUY NOW](#)



**RDK-801 LED Lighting**

[BUY NOW](#)



**Industrial Power Supply Unit**

[BUY NOW](#)

**CONCLUSION**

Power Integrations' 1700 V GaN device redefines power electronics, offering superior efficiency and cost-effectiveness over SiC, MOSFETs, and IGBTs. As GaN scales to higher power applications, it's poised to dominate diverse markets. Explore our GaN solutions at the ATOM distributor site.

[CLICK HERE](#)

# REVOLUTIONISING POWER ELECTRONICS

## SIC AND GAN WIDE-BANDGAP SEMICONDUCTORS

Silicon-based devices have conventionally been the backbone of power electronics; however, issues concerning efficiency, thermal performance, and voltage handling have created a shift toward the use of Silicon Carbide (SiC) and Gallium Nitride (GaN) wide-bandgap semiconductors. These will dramatically improve switching speeds, power density, and overall system efficiency – the key factor for modern high-performance power systems.

## THE FUNDAMENTALS: WHY WIDE-BANDGAP?

Before getting to SiC and GaN, we must understand why “wide-bandgap” matters. A little background: a semiconductor’s bandgap is the amount of energy it takes for electrons to jump from the valence band into the conduction band, and start conducting electricity. Traditional silicon has a relatively narrow bandgap (~1.1 eV), which limits its performance at higher voltages and temperatures.

SiC and GaN both have much wider bandgaps, at about 3.26 eV for SiC and around 3.4 eV for GaN. The immediate advantages of such a wider bandgap include the following:

- Higher breakdown voltages, allowing devices to operate at significantly higher voltages without material breakdown.
- Improved thermal conductivity means they can operate more efficiently at higher temperatures without performance degradation.
- Faster switching speeds, leading to lower switching losses and higher operational efficiencies.

These properties make SiC and GaN particularly well-suited to the future of power electronics, where efficiency and miniaturisation are of prime importance.

## SILICON CARBIDE (SiC): HIGH-POWER, HIGH-VOLTAGE APPLICATIONS

Within a very short period, SiC has found its place in high voltage applications regarding robust thermal management and high reliability, especially in EVs and industrial motor drives. As a matter of fact, the superior material properties make SiC particularly suited for applications above 1kV, where silicon performance shows evident deterioration.

### KEY BENEFITS OF SiC:

- **Higher power conversion efficiency:** SiC devices, especially MOSFETs and Schottky diodes operating at more than 1200V with less energy loss compared with their silicon cousins, have been applied to the power converters of electric vehicles. Of course, EVs’ primary targets are maximising battery life and minimising dissipation heat.
- **Thermal stability:** Due to its higher thermal conductivity, it can operate efficiently at much higher temperatures- up to 200°C. This greatly eliminates the need for complex cooling systems, reducing design complexity and operational costs.
- **High Power Density:** Switching at higher frequencies allows SiC components to enable designers to shrink passive component sizes, such as inductors and capacitors, thereby leading to smaller and lighter systems. This is extremely useful when space and weight are of essence, as in aerospace and EV inverters.

### KEY SiC DEVICE TYPES:

- **SiC MOSFETs:** These devices offer high breakdown voltage-up to 3.3 kV, low on-resistance (RDS(on)), and fast switching speeds, which result in improved efficiency and reduced energy losses within high-power systems such as EV inverters and solar inverters.
- **SiC Schottky Diodes:** With their low forward voltage drop and zero reverse recovery, the SiC Schottky diodes significantly reduce the switching losses, hence targeting a wide application area in power factor correction (PFC) circuits and DC-DC converters.

#### Example: EV Inverter Using SiC MOSFETs

In the conventional v, SiC MOSFETs replace silicon IGBTs to enable higher-frequency switching-up to 50 kHz-on the order of an order of magnitude higher than conventional technologies. This can reduce the size of passive components, inductors, and capacitors and reduce overall system size.



### OVERCOMING CHALLENGES:

- **High Cost:** SiC devices have traditionally been more expensive than silicon because the manufacturing processes are more complicated, for example, with regard to defect control in crystal growth. However, price reductions are happening with scale of production.
- **Gate Oxide Reliability:** Early SiC MOSFETs encountered some issues with gate oxide reliability. Many of these problems have been surmounted with the introduction of enhanced epitaxial growth techniques and gate oxide engineering, improving device longevity.

## GALLIUM NITRIDE (GAN): HIGH-SPEED, HIGH-FREQUENCY APPLICATIONS

GaN excels in high-speed, high-frequency applications where fast switching and efficiency are paramount. Typically, the voltage range of operation for GaN devices is below 1 kV, but they have superior switching performance compared to Si and SiC.

### KEY BENEFITS OF GAN:

- **High Switching Frequency:** Most GaN power transistors can operate above 1 MHz, which reduces passive components’ size and increases overall system efficiency. What makes them especially attractive is high-density applications like server power supplies and consumer electronics, where energy efficiency and size are important.
- **Low On-Resistance (RDS(on)):** Most GaN devices feature much lower on-resistance than silicon, thereby reducing conduction losses in high-current applications. What follows immediately after this is higher efficiency in power delivery and more compact designs.

- **Improved efficiency in RF applications:** It would be worthy to make use of it for RF amplifiers in wireless communications without having any significant loss due to their feasibility at high frequencies. It is also a highly promising material for next-generation 5G infrastructure, demanding high power efficiency and fast signal transmission.

### KEY GAN DEVICE TYPES:

- **GaN HEMTs:** With an extremely low RDS(on) and ultra-fast switching speeds of up to MHz, in switch-mode power supplies (SMPS), telecom power amplifiers and RF circuits, these devices outperform silicon MOSFETs.
- **GaN-on-Si Devices:** One of the popular approaches for the integration of GaN layers onto silicon substrates is to achieve cost-effective solutions in high-frequency power conversion.

#### Example: GaN in SMPS

A GaN-based SMPS operates at frequencies higher than 1 MHz and allows passive component size reduction, higher efficiency, and high power density. In the PFC circuit, inductors may be much smaller since GaN can support higher switching frequencies of the switches. Also, the system size is substantially reduced.

### OVERCOMING CHALLENGES:

- **Thermal Management:** For the time being, GaN exhibits lower thermal conductivity than SiC, and such traits may limit its use in high-power applications unless novel thermal management methods are employed, such as substrate cooling.
- **Substrate Limitations:** While GaN-on-Si lowers the cost, this can also introduce lattice mismatches, which can lead to issues of reliability. These are mitigated with continuing advances in substrate engineering.

## SiC VS. GaN: APPLICATION-SPECIFIC STRENGTHS

- SiC has the edge in high-power and high-voltage applications where reliability and thermal performance are essential.
- GaN, on the other hand, is preferred in applications requiring high-frequency operation with medium power due to its faster switching and lower conduction losses.

### APPLICATION MATRIX:

Application	Voltage Range	Preferred Material	Key Requirement
EV Inverters	800V - 1200V	SiC	High voltage & efficiency
Telecom Power Supplies	48V - 600V	GaN	High frequency & compact size
Solar Inverters	> 1 kV	SiC	Thermal management & reliability
Consumer Chargers	< 600V	GaN	Small size & efficiency

### MARKET ADOPTION TRENDS

- Electric Vehicles (EVs) and Charging Infrastructure: SiC is being adopted in the design of EV inverters and fast-charging stations because it can handle high voltage in a more efficient way. Though still uncommon in EV powertrains, GaN does find application in on-board chargers and low-power auxiliary systems.
- Telecom and 5G Infrastructure: GaN has been reported to support high-frequency switching, which makes it suitable in applications such as 5G base stations where efficient power amplification and minimum heat generation are required.
- Renewable Energy: Both SiC and GaN are used in solar inverters, with SiC yielding higher efficiency at high voltage, while for lower-power converters, the trend is towards GaN because of its switching speed.
- Consumer Electronics: The high-frequency operation of gallium nitride is also used in compact high-efficiency power supplies for consumer electronics applications: smartphones, laptops, and even wireless chargers. Gallium nitride-based chargers are becoming more mainstream, with smaller sizes and higher-speed charging capability.



### FURTHER READ:

- Wide-Bandgap Semiconductor: The Future of SiC and GaN Technology
- Powerful possibilities with Microchip SiC
- Compact isolated gate driver power supply for sic-mosfets
- Enhancing industrial energy efficiency with SiC and GaN technology
- Application benefits of using 4th Generation SiC MOSFETs
- GaN and SiC benefits in industrial electronics

## CONCLUSION

SiC and GaN wide-bandgap semiconductors represent the new faces in the field of power electronics. SiC-based devices find their use in robust, high-powered applications because of their high-voltage and high-efficiency capability, while GaN applies to compact and low-power systems owing to its high-frequency performance. As cost and manufacturing continue to get overcome, wide adoptions are inevitable across the industries, including EVs, telecom, and renewable energy.

- 👉 Silicon Carbide (SiC) MOSFETs & Modules
- 👉 Gallium Nitride (GaN) MOSFETs & Modules

# POWER MANAGEMENT SOLUTIONS

## EFFICIENT, RELIABLE, SCALABLE

Advanced DC-DC Converters for Optimized Performance

### DC-DC CONVERTERS

Discover extensive range of DC-DC converters, engineered for design excellence and industry-leading performance. Our portfolio features high-efficiency converters from industry-leading suppliers, ideal for consumer electronics, automotive, and industrial applications, they ensure reliable power solutions. Access the best products and expert support through our global network.

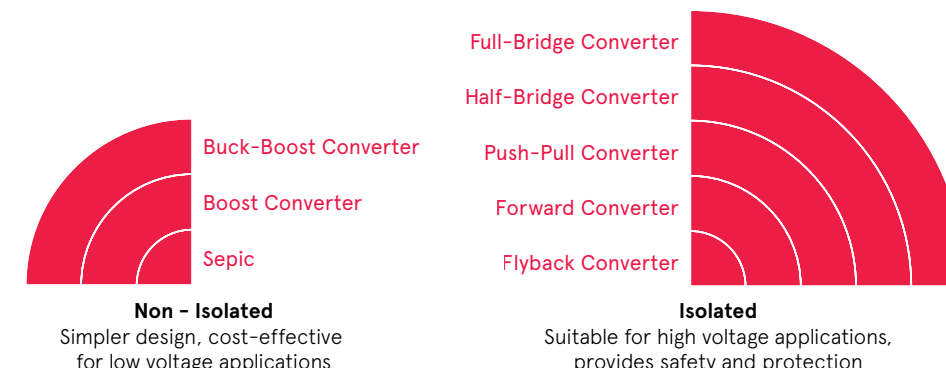

### MARKET TRENDS

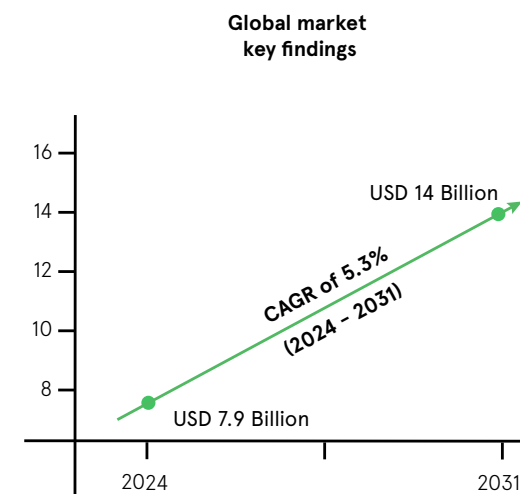

**Global DC - DC Converters market trend by end user**

<b>Energy &amp; power</b> 24.85% Buck, Boost, Buck -Boost, SEPIC, Flyback, Forward, Push-Pull, Half & Full Bridge	<b>Automotive</b> 20.14% Buck, Boost, Buck - Boost, SEPIC, Push -Pull, Half-Bridge	<b>Telecommunication</b> 16.44% SEPIC, Forward, Full Bridge
<b>Consumer Electronics</b> 19.32% Buck, Boost, Buck -Boost, Flyback, Push-Pull	<b>Aerospace &amp; Defense</b> 9.45% SEPIC, Buck, Boost, Flyback	<b>Healthcare</b> 7.62% Flyback, Buck, Boost

### KEY SUPPLIERS



## TYPES

### BUCK CONVERTERS

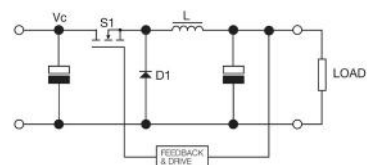

Reduce input voltage to a lower output voltage

**Applications:**

- > Consumer electronics
- > Automotive electronics
- > Power supplies

### BOOST CONVERTERS

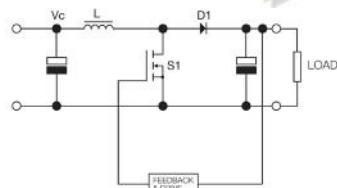

Increase input voltage to a higher output voltage

**Applications:**

- > Power amplification
- > Renewable energy systems
- > Automotive electronics
- > Battery power systems
- > Consumer electronics

### BUCK - BOOST CONVERTERS

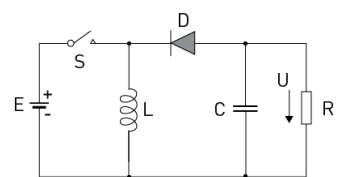

Can either increase or decrease input voltage

**Applications:**

- > Renewable energy systems
- > Automotive electronics
- > Consumer electronics

### PUSH-PULL CONVERTERS

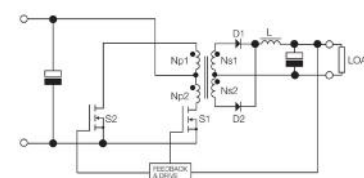

Use two transistors to provide high-efficiency voltage conversion.

**Applications:**

- > Renewable energy systems
- > Power supplies for Consumer appliances
- > Automotive electronics

### HALF-BRIDGE CONVERTERS

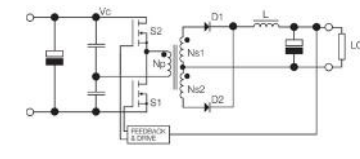

Use a transformer for electrical isolation and can provide higher or lower output voltage.

**Applications:**

- > SMPS
- > Motor Drives & Inverters

### FULL-BRIDGE CONVERTERS

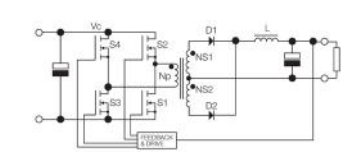

Use four switches and a transformer to efficiently change DC voltage.

**Applications:**

- > Automotive EVs and HEVs
- > Renewable Energy
- > Communication devices

### SEPIC CONVERTERS

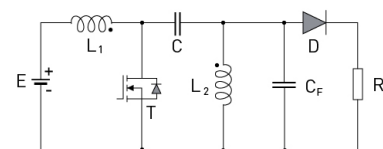
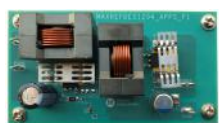

Can adjust output voltage higher, equal to, or lower than input voltage.

**Applications:**

- > Battery power system
- > Industrial & Automotive
- > Communication devices

### FLYBACK CONVERTERS

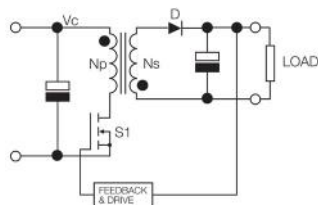

Use a coupled inductor to store and release energy

**Applications:**

- > Medical devices
- > Power supplies for Consumer appliances
- > Aerospace engineering

### FORWARD CONVERTERS

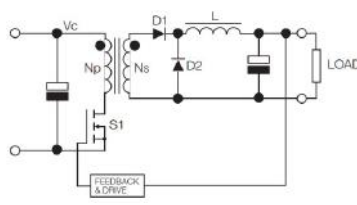

Use a transformer to isolate the input and output.

**Applications:**

- > Communication devices
- > Battery powered systems
- > Power supplies for Consumer appliances

### On-Board Components

- > Line converters and Switches
- > Voltage regulators
- > Power distribution
- > PWM controllers
- > Isolated surface-mount converters

- > MOSFET drivers
- > Self-isolating half-bridge driver IC
- > Schottky diodes
- > Evaluation kits

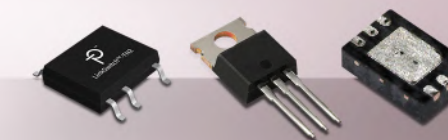

[BUY NOW](#)

### Off-Board Components

- > Isolated power supplies for medical devices
- > Isolated DIN Rail mount DC/DC converters
- > DIN rail mount converters

- > Buck - Boost Converters
- > PoEs (Power over Ethernet)
- > PWM controllers
- > UPS (Uninterruptible Power Supply)



[BUY NOW](#)

# INDUSTRIAL POWER SOLUTIONS

Modular AC-DC Power Supplies offer versatile, configurable and programmable voltage and current outputs for industrial equipment, ensuring precision and efficiency in demanding environments.

Explore the range:

[CLICK HERE](#)



# POWER UP WITH RELIABLE CABLES & CONNECTORS

Maximize system performance with high-quality silicone-insulated cables, tinned copper wire, and high-voltage power cables, paired with reliable connectors for secure connections across various applications.

Explore the range:

**Cables**

[CLICK HERE](#)

**Connectors**

[CLICK HERE](#)

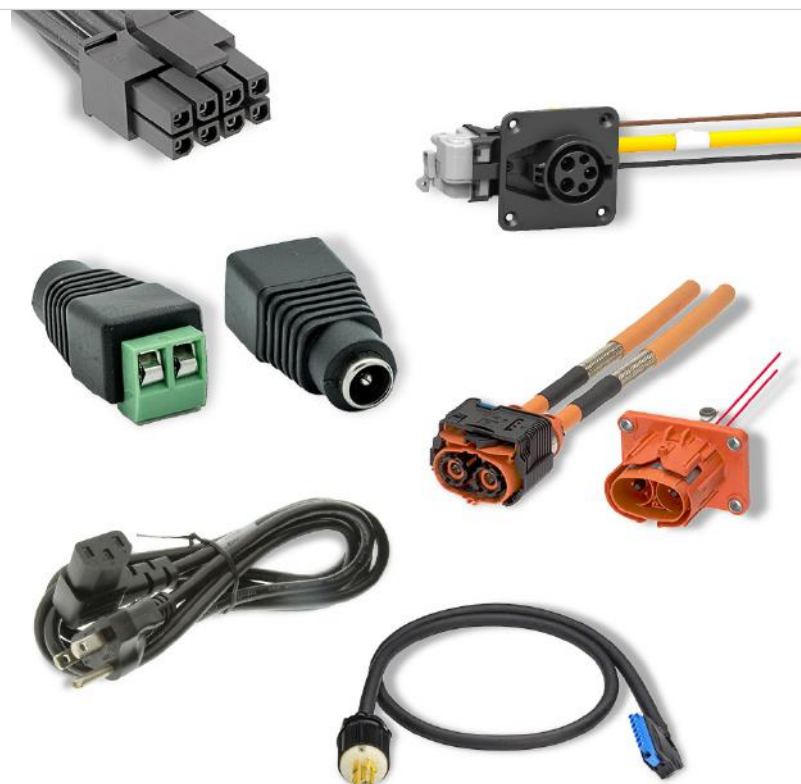

**multicomp** PRO

## THE ENGINEER'S CHOICE

For Quality & Value  
From Prototype to Production

### KEY APPLICATIONS



Electronics Lab /  
Prototyping



PCB Components



Industrial Automation &  
Control



Production & MRO

[farnell.com/multicomp-pro](https://farnell.com/multicomp-pro)



# TECHNICAL RESOURCES

Explore our well-curated library of whitepapers, technical articles, videos, training modules, tutorials, and more to support you in developing your designs, business, and career.

