

# HIGH-SPEED CABLE

## INTERCONNECT SOLUTIONS GUIDE

# HIGH-SPEED CABLE SOLUTIONS

## SAMTEC FLYOVER<sup>®</sup> ARCHITECTURE

Improves Signal Integrity & Reach  
at Higher Data Rates

In-House High Level Design  
& Engineering Support

Full System Signal Integrity Expertise



## FLEXIBILITY & CUSTOMIZATION

Mix & Match Connector End Options

Extensive Customization Capabilities

Modular Backplane Flexibility

## MANUFACTURING & CAPABILITIES

R&D/Manufacturing of Precision  
Extruded Cable & Next Gen RF  
Cable in Several Global Locations

Multiple Proprietary  
Ultra-High Performance Cable  
Technologies



# TABLE OF CONTENTS

<b>HIGH-SPEED CABLE OVERVIEW</b> .....	4-5
--	-----

## FLYOVER® SYSTEMS

Flyover® Technology .....	6-7
Panel Assemblies .....	8-9
Mid-Board Assemblies .....	10-13
Backplane Assemblies .....	14-15

## HIGH-SPEED CABLE SYSTEMS

Mix-and-Match Assemblies .....	16-17
Customized Assemblies .....	18-19
Eye Speed® Cable Specifications, Testing & System Optimization .....	20-21

<b>OPTICAL SYSTEMS</b> .....	22-23
------------------------------	-------

<b>RF SOLUTIONS</b> .....	24-25
---------------------------	-------

## INNOVATION, EXPERTISE & SUPPORT

Technology & Global Manufacturing Capabilities .....	26
Evaluation & Development Kits .....	27
Sudden Service® Online Tools & Resources .....	28-29
Integration Leads to Innovation / Silicon-to-Silicon™ Solutions .....	30-31

# HIGH-SPEED CABLE PRODUCT OVERVIEW



**FLYOVER® SYSTEMS | 6-15**

224 Gbps PAM4 EXTREME PERFORMANCE | INDUSTRY'S HIGHEST DENSITY | ASIC ADJACENT & ON-PACKAGE  
CABLE-TO-CABLE, CABLE-TO-BOARD & CABLE-TO-PANEL | ULTRA LOW SKEW & ULTRA PERFORMANCE TWINAX CABLE



## HIGH-SPEED CABLE ASSEMBLIES | 16-19

MICRO COAX & TWINAX CABLE | MIX-AND-MATCH END OPTIONS | ARRAYS, GROUND PLANE & EDGE CARD SYSTEMS  
 PCIe® 2.0/3.0/4.0/5.0 | EDGE RATE® RUGGED, HIGH-SPEED CONTACTS

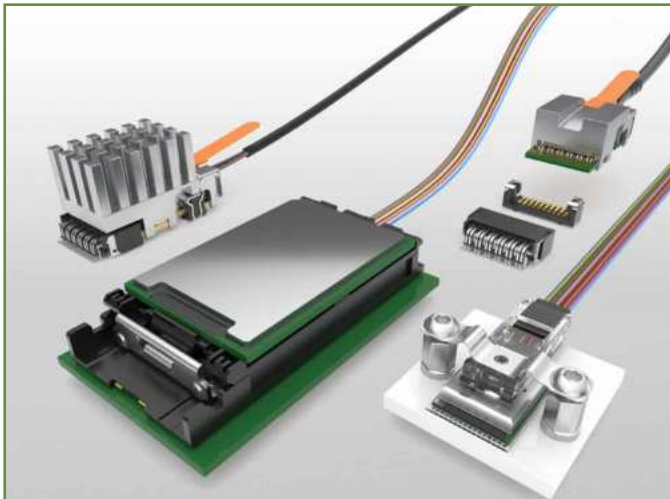

## OPTICAL SYSTEMS | 22-23

FUTURE PROOF | EXTREME ENVIRONMENT | PCIe® 3.0/4.0  
 RUGGED OPTICAL TRANSCEIVERS | NEXT GEN 112 Gbps

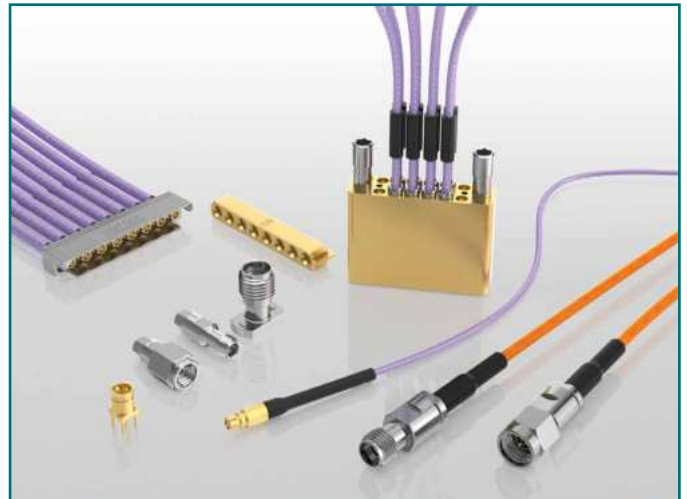

## RF SOLUTIONS | 24-25

TESTING TO 90 GHz | PRECISION RF CABLES & CONNECTORS  
 FLEXIBLE WAVEGUIDES | NEXT GEN RF CABLE

# FLYOVER<sup>®</sup> TECHNOLOGY



## THE PROBLEM

### PCB REACH AT NEXT GEN SPEEDS

As bandwidth requirements rapidly increase, effectively managing heat and routing signals through lossy PCBs, vias and other components have become complex challenges.

### BANDWIDTH VS. TRADITIONAL & HIGH-SPEED MATERIALS

(Comparison at -5 dB Insertion Loss Point)

	FR408	MEGTRON 6	MICRO TWINAX
PAM4 56 Gbps	0.0"	up to 2"	36"+
PAM4 112 Gbps	0.0"	0.0"	18"+

## THE SOLUTION

### SAMTEC FLYOVER<sup>®</sup> SYSTEMS

Samtec Flyover<sup>®</sup> design breaks the constraints of traditional signaling substrate and hardware offerings, resulting in a cost-effective, high-performance and heat efficient answer to the challenges of 56 Gbps bandwidths and beyond.

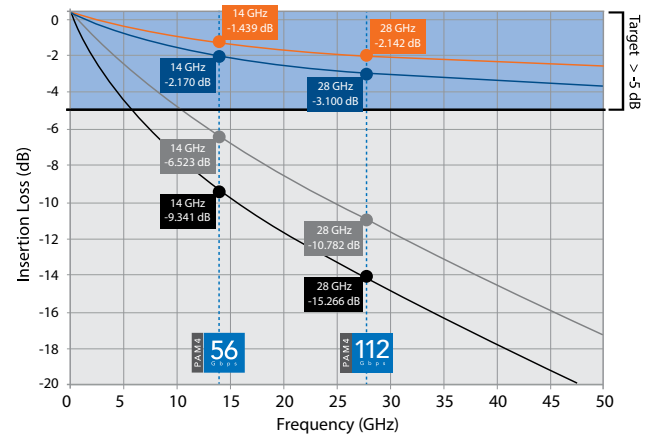

■ 30 AWG 100 Ω Eye Speed<sup>®</sup> Low Skew Twinax Cable  
■ 34 AWG 100 Ω Eye Speed<sup>®</sup> Low Skew Twinax Cable  
■ Low Loss Backplane PCB trace, 5.7 mil wide, 8.3 mil space  
■ Ultra Low Loss Backplane PCB trace, 5.7 mil wide, 8.3 mil space  
\*Loss values based on 12" trace.

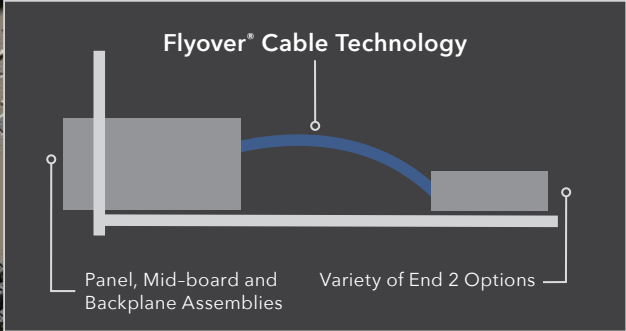
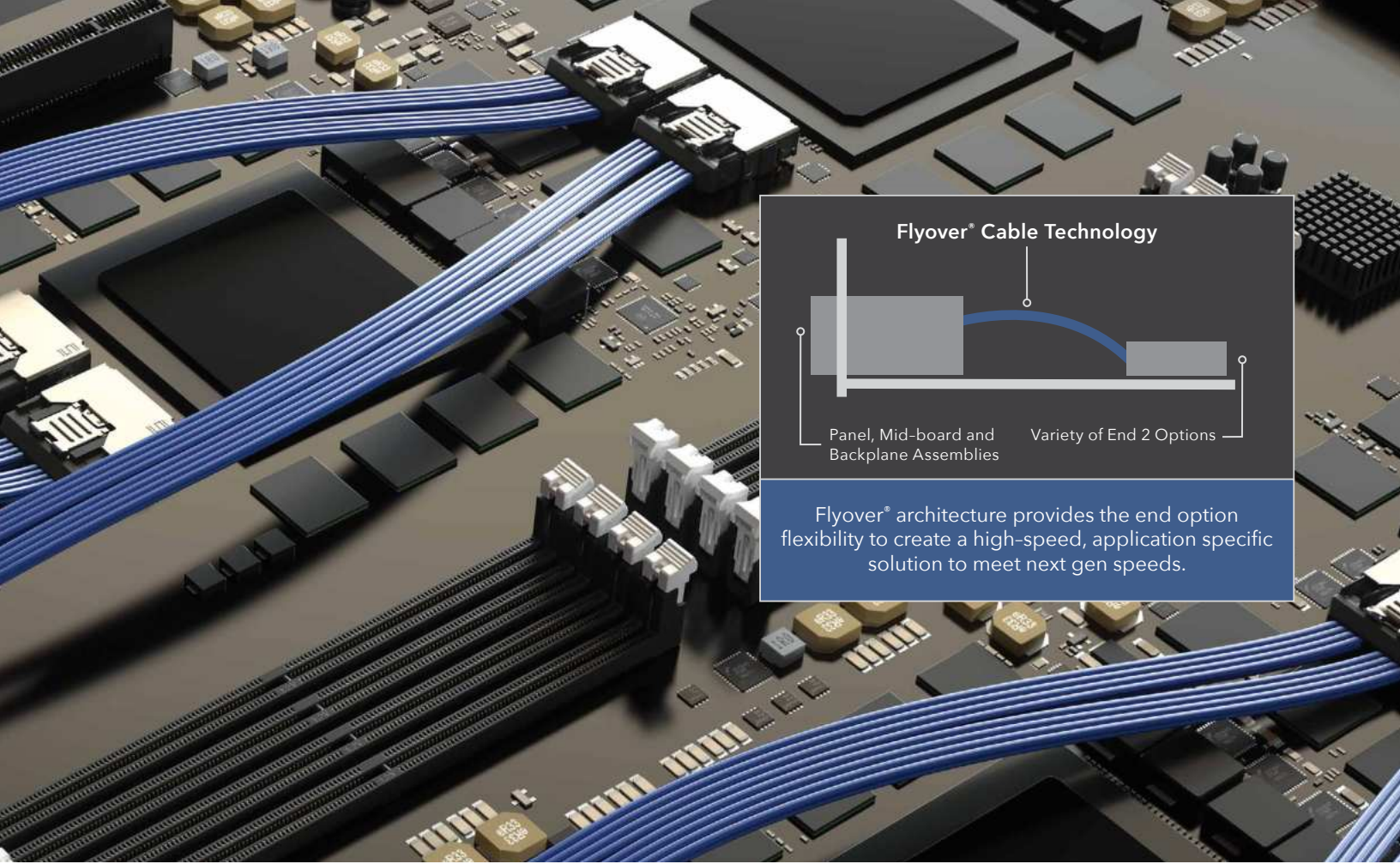

Flyover® architecture provides the end option flexibility to create a high-speed, application specific solution to meet next gen speeds.

## EYE SPEED® TWINAX CABLE TECHNOLOGY

- Ideal for 28-112+ Gbps applications
- Tight coupling between signal conductors
- Ultra low skew twinax < 3.5 ps/meter
- 40% smaller cross-sectional area (Thinax™)
- See page 20-21 for cable specifications
- In Development: Eye Speed® AIR foamed twinax for significantly improved signal integrity and even lower intra-pair skew

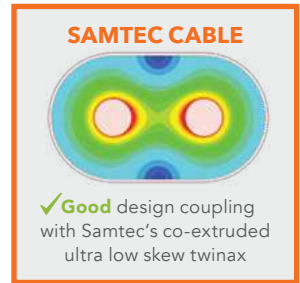
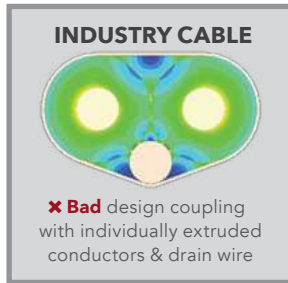

## PERFORMANCE & COST ADVANTAGES

- 28-56 Gbps NRZ & Beyond
- Simplified Board Layout
- Fewer PCB Layers
- Less Expensive PCB Materials
- Eliminate Expensive Re-timers

NRZ	PAM4	NRZ	PAM4
28 Gbps	56 Gbps	56 Gbps	112 Gbps

## SUPPORT

Fully integrated technology teams provide support to enable full system optimization from Silicon-to-Silicon™. See page 26 for information about Samtec's High-Speed Cable Plants.

## THERMAL IMPROVEMENT

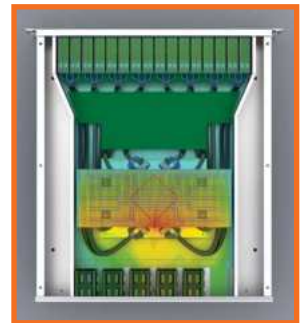
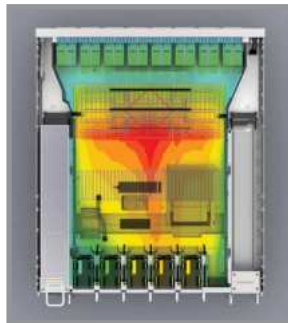

Standard Network Switch vs. Samtec Flyover® Technology

# FLYOVER® PANEL ASSEMBLIES

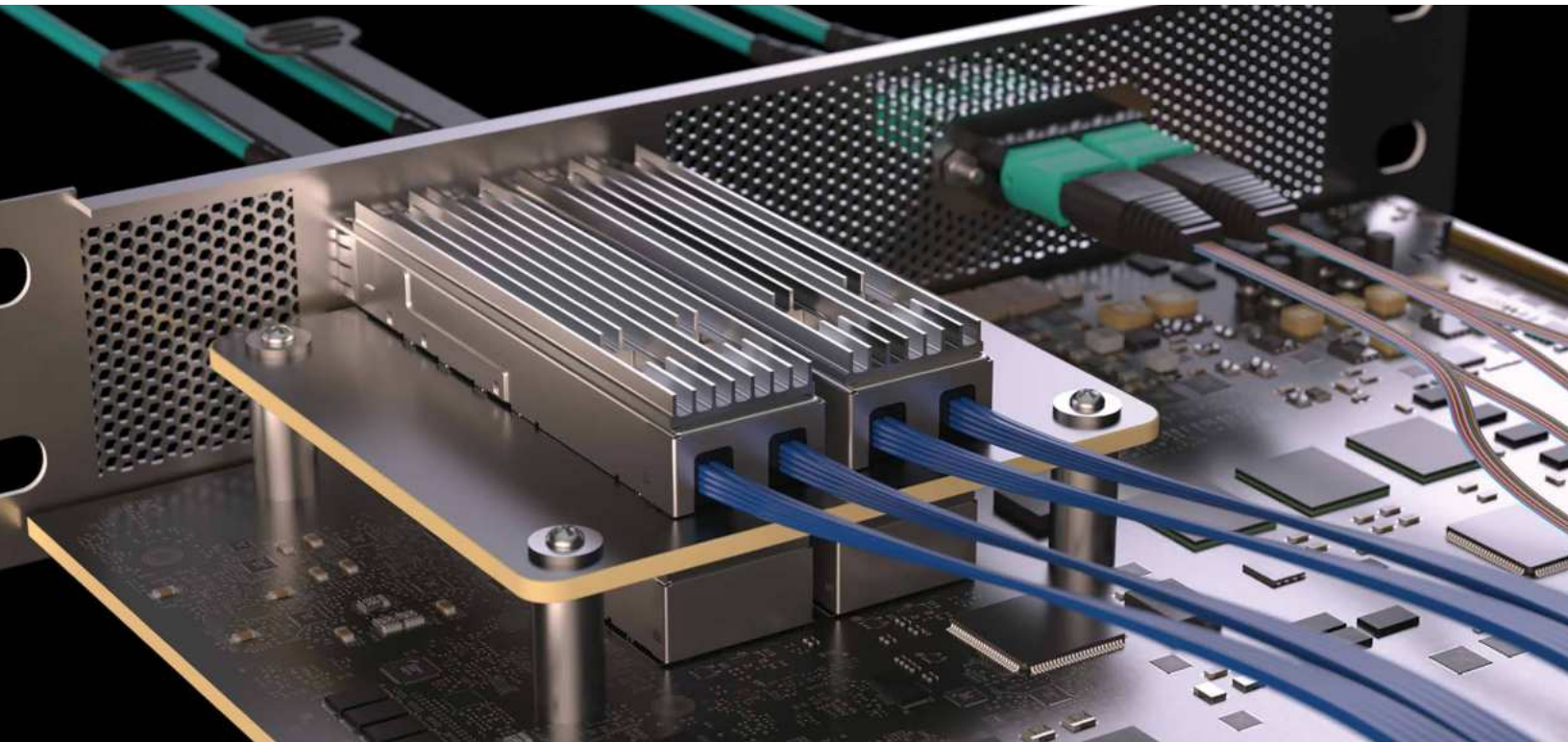

## FLYOVER® QSFP SYSTEMS

- Up to 800 Gbps PAM4 aggregate data rate (112 Gbps PAM4 per channel)
- 4 channels (x4 bidirectional, 8 differential pairs) or 8 channels (x8 bidirectional, 16 differential pairs)
- Double density versions feature belly-to-belly mating for maximum density (FQSFP-DD, FQSFP-D8)
- Multiple heat sink options for optimal dissipation
- Variety of end 2 options including AcceleRate®, NovaRay®, Si-Fly™, FireFly™ and ExaMAX®
- Evaluation Kits available, see page 27 or visit [samtec.com/kits](http://samtec.com/kits)
- Additional front panel ports in development: SFP112, OSFP200



NRZ	PAM4
56 Gbps	112 Gbps

FQSFP-D8

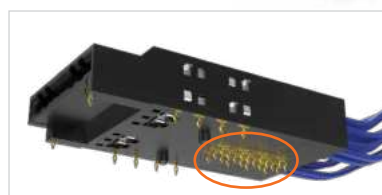
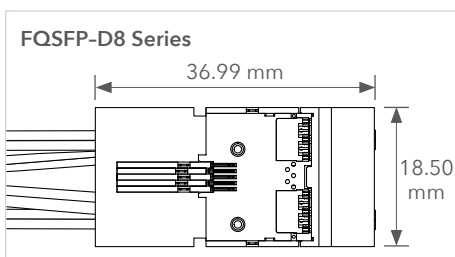

Sideband signals are routed through press-fit contacts for increased airflow

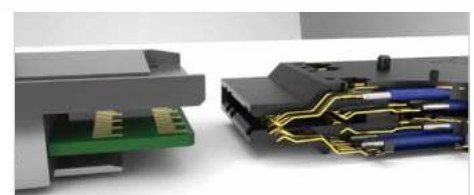

High-speed contacts directly soldered to Eye Speed® ultra low skew twinax

## NOVARAY® I/O EXTREME PERFORMANCE SYSTEM

- Up to 3,584 Gbps PAM4 aggregate data from the IC package to the panel and beyond
- No heat sinks required for panel space savings
- 16 and 32 differential pair configurations
- Accommodates PCIe® x4 or x8 plus sidebands
- 28 or 34 AWG (external) and 34 AWG (internal) ultra low skew twinax
- Cable-to-cable bulkhead panel connection using Flyover® cable technology
- Multiple end 2 high-speed connector options including AcceleRate®, NovaRay® and Si-Fly™

**NOVARAY® I/O**



NVACP/NVACE/NVC

PAM 4

**112**  
Gbps

**PCI EXPRESS®**  
6.0 Capable

TARGETED CONFIGURATIONS	AGGREGATE DATA RATE
8 Pair (in development)	896 Gbps
16 Pair	1792 Gbps
32 Pair	3584 Gbps
x4 (8 Pair + PCIe® Sidebands)	512 Gbps
x8 (16 Pair + PCIe® Sidebands)	1024 Gbps

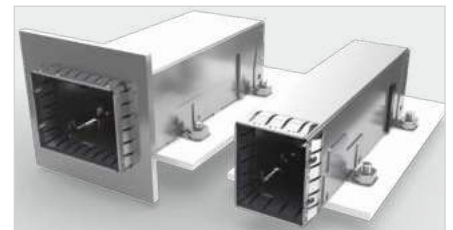

Right-angle to front panel available for design flexibility

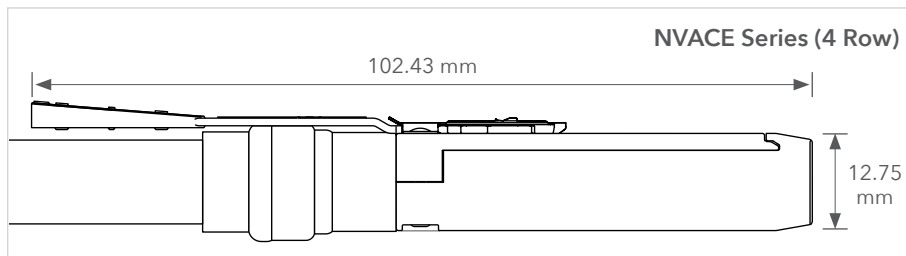

Roadmap: NovaRay® I/O in a rugged 38999 shell & salt fog resistant to 48 hours

PCI-SIG®, PCI Express® and the PCIe® design marks are registered trademarks and/or service marks of PCI-SIG.

## ExaMAX® I/O SHIELDED CABLE SYSTEM

- Fully shielded external cable and cage for EMI protection
- Rugged pull latch for mating/unmating
- Cage designed for use with ExaMAX® right-angle board connector (EBTM-RA)
- 30 and 34 AWG ultra low skew twinax
- 24 to 72 pairs (4 and 6 pairs; 6, 8, 10 and 12 columns)
- Roadmap: cable-to-cable bulkhead panel connection for increased performance to 112 Gbps PAM4

**ExaMAX®**

PAM 4

**56**  
Gbps

EBCE/EBTC



ExaMAX® is a registered trademark of AFCI.

# FLYOVER<sup>®</sup>

## MID-BOARD ASSEMBLIES

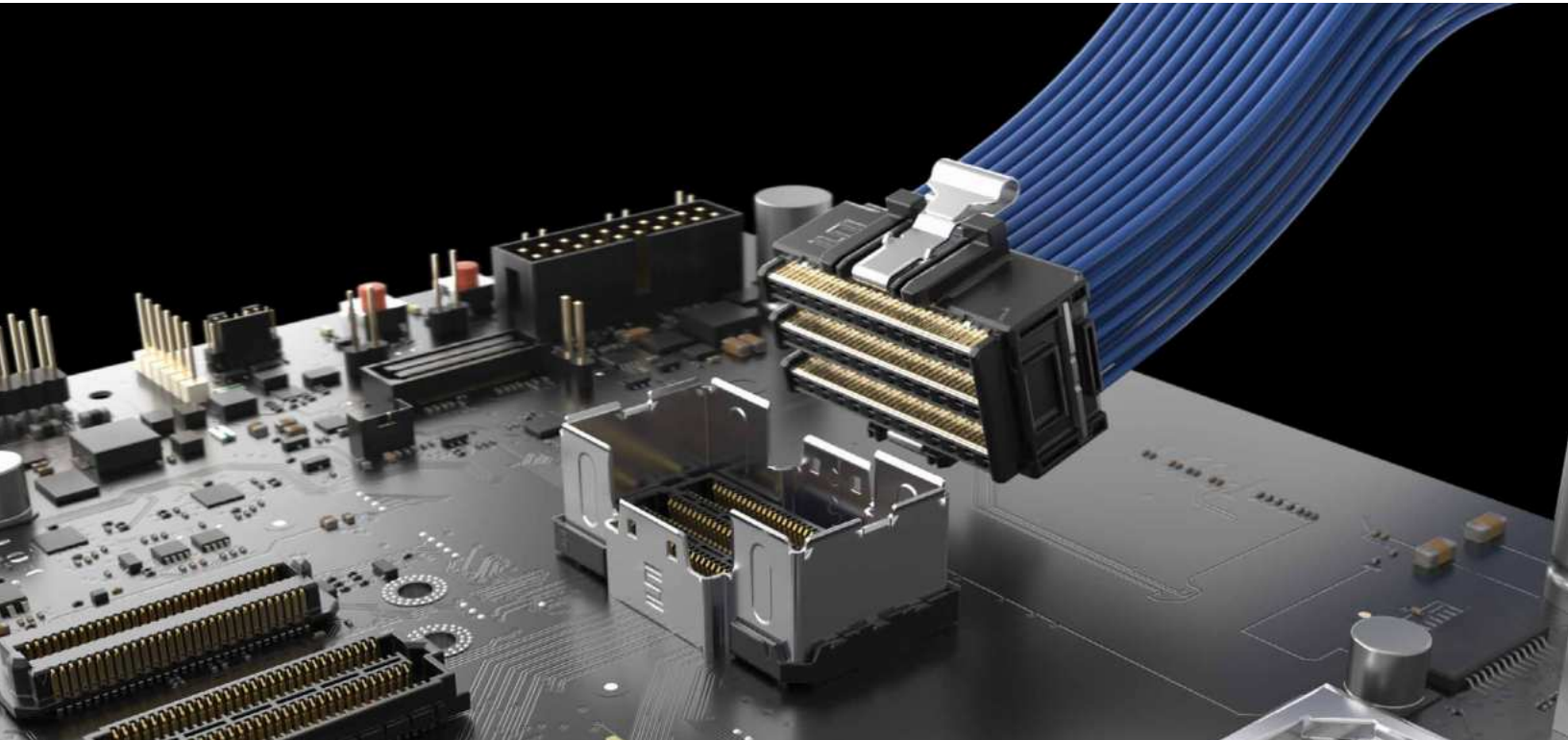

### NOVARAY<sup>®</sup> EXTREME HIGH-SPEED, HIGH-DENSITY CABLE

- Industry leading aggregate data rate density – 2x the data rate in 60% of the space
- Proprietary pin to ground configuration enables very low crosstalk (to 40 GHz) and very tight impedance control
- Two reliable points of contact guaranteed
- BGA attach for density and optimized trace breakout region
- Evaluation Kits available, see page 27 or visit [samtec.com/kits](http://samtec.com/kits)

NRZ	PAM4
<b>56</b> Gbps	<b>112</b> Gbps

**NOVARAY<sup>®</sup>**

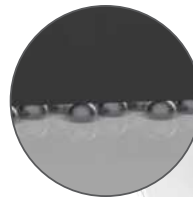

NVAC/NVAM-CT

AGGREGATE DATA RATE (NRZ)						
448 Gbps	672 Gbps	896 Gbps		1344 Gbps	1792 Gbps	4032 Gbps*
1 Bank				2 Bank		3 Bank*
2 Row	3 Row	4 Row	2 Row	3 Row	4 Row	6 Row*
8 Pairs	12 Pairs	16 Pairs		24 Pairs	32 Pairs	72 Pairs*

\*In development

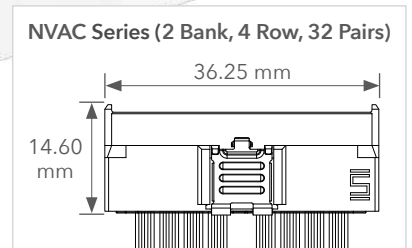

## ACCELERATE® HP EXTREME DENSITY SYSTEM

- Industry's highest density 112 Gbps PAM4 cable-to-board system
- Supports today's 256-channel chip and tomorrow's 512-channel chip
- Staggered row-to-row spacing of 2.2 mm x 2.4 mm allows adequate routing lanes for optimized traces; 0.635 mm contact pitch
- 32 to 72 differential pairs; up to 96 pairs in development
- Eye Speed® 34 AWG ultra low skew twinax cable
- BGA solder ball attach for simplified processing
- Right-angle shielded mating connector in development (APF6-RA)

**ACCELERATE®HP**



Locking available for maximum density

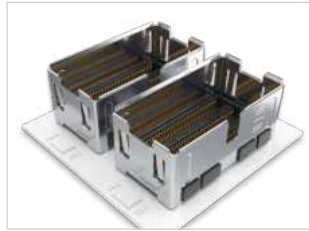
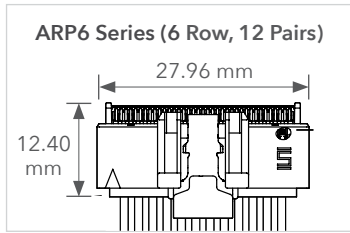

NRZ	PAM4
<b>56</b> Gbps	<b>112</b> Gbps

35 mm x 35 mm footprint holds two 72 differential pair connectors (144 total pins)

## ACCELERATE® HP GEN 2 ON-PACKAGE SYSTEM

- Samtec is the first to achieve a direct-to-chip package solution with the industry's highest density 112 Gbps PAM4 interconnect
- Double the density in the same Gen 1 footprint; up to 144 differential pairs
- 182 differential pairs per square inch
- Staggered row-to-row spacing; 0.635 mm contact pitch
- Eye Speed® Thinax™ ultra performance twinax cable (see page 20 for information)
- Vertical cable application provides the highest footprint density
- 2-piece system for high reliability and thermal performance required for co-packaged solutions
- Roadmap: Single-ended signaling micro coax cable assembly, and mixed wafer technology with micro coax and Thinax™ cable

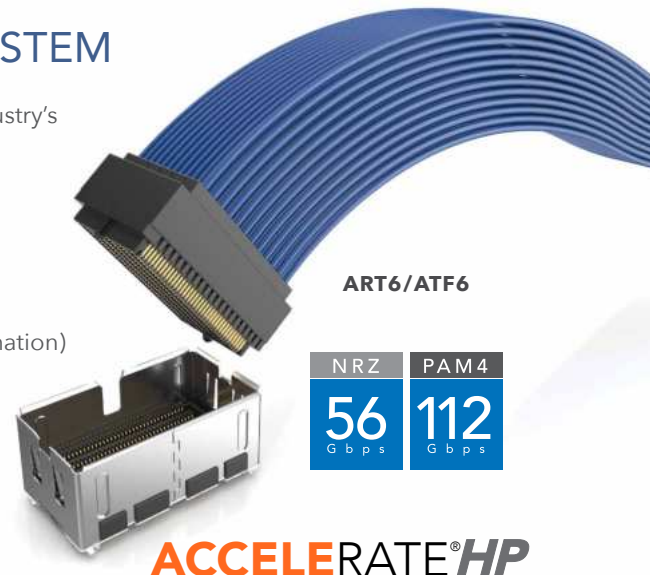

NRZ	PAM4
<b>56</b> Gbps	<b>112</b> Gbps

**ACCELERATE®HP**

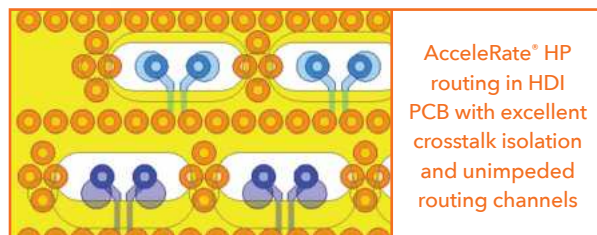
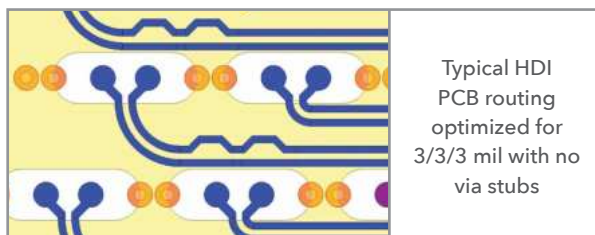



## ACCELERATE® SLIM, DIRECT ATTACH SYSTEM

- Slimmest cable assembly in the industry – 7.6 mm width
- 8, 16 and 24 differential pair configurations in a high-density 2-row design; 72 pairs in development
- PCIe® 5.0 capable
- Contacts directly soldered to the cable improves signal integrity by eliminating the transition board and its variability
- Eye Speed® 34 AWG ultra low skew twinax cable
- Rugged metal latching and shielding
- “Reversed Polarity” pinout option for reduced Far-End Crosstalk
- Evaluation Kit available, see page 27 or visit [samtec.com/kits](http://samtec.com/kits)

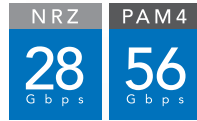

### ACCELERATE®

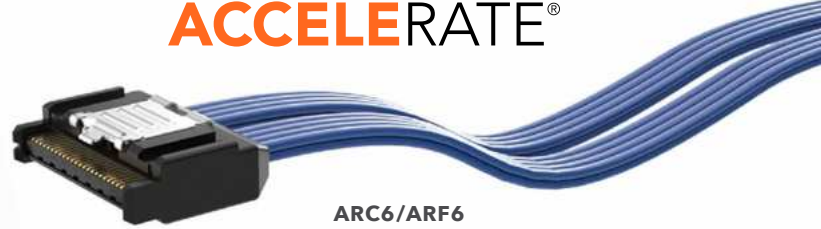

ARC6/ARF6



Right-angle board mate available

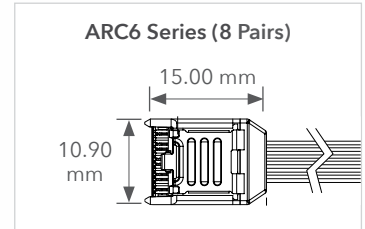

## ACCELERATE® MINI EXTREME PERFORMANCE SYSTEM

- Design flexibility as an End 2 option for Flyover® assemblies
- One or two differential pairs
- Eye Speed® 34 AWG Thinax™ ultra performance twinax cable (see page 20 for more information)
- Vertical and right-angle mating board connector

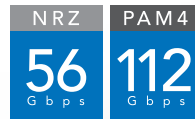

### ACCELERATE® mini

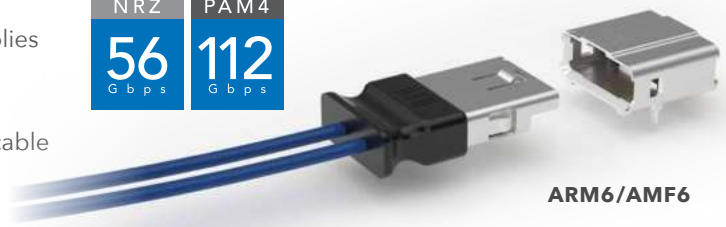

ARM6/AMF6

## GENERATE™ HIGH-SPEED EDGE CARD SYSTEM

- Compatible with SFF-TA-1002 (1C, 2C, 4C & 4C+)
- Surpasses PCIe® 4.0 and 5.0 performance requirements
- Edge Rate® contacts optimized for signal integrity performance
- Vertical or right-angle cable launch
- Mates with Generate™ 0.60 mm pitch high-speed edge card socket (HSEC6)
- Rugged metal latching system

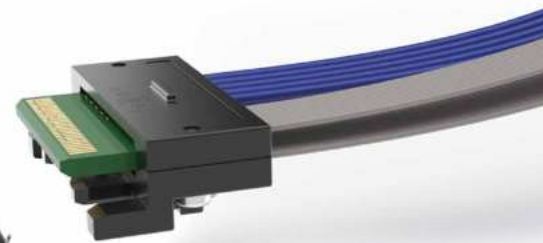
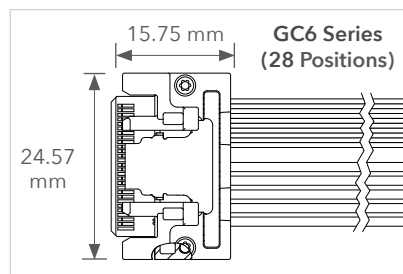

GC6/HSEC6

### GENERATE™

## SI-FLY™ LOW PROFILE CABLE SYSTEM

- Up to 16 pairs in an extremely low 3.8 mm profile for placement adjacent to the IC package, under heat sinks or other cooling hardware
- 112 Gbps PAM4 per lane enabling 25.6 TB aggregate with a path to 51.2 TB
- High-density 8 or 16 pairs for routing 4 or 8 channels
- Eye Speed® 34 AWG ultra low skew twinax cable
- 8.4 mm minimum height required for mating
- Evaluation Kit available, see page 27 or visit [samtec.com/kits](http://samtec.com/kits)

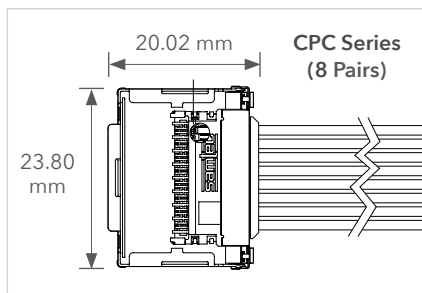
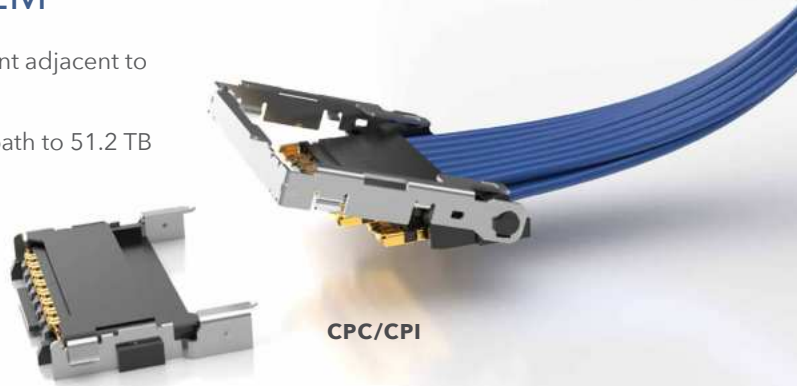

SI-FLY™ LP

NRZ	PAM4
56 Gbps	112 Gbps

## SI-FLY™ HIGH-DENSITY ON-PACKAGE SYSTEM

- Vertically launched cables for the highest density package
- 64 pairs in an incredibly small 13 mm x 13 mm footprint
- 245 differential pairs per square inch
- 0.53 mm (Signal-Ground) and 0.40 mm (Signal-Signal) contact pitch; 1.25 mm row-to-row pitch
- Designed for High Density Interconnect (HDI) and package substrates
- Eye Speed® Thinax™ ultra performance twinax cable (see page 20 for additional information)

SI-FLY™ HD

PAM4
224 Gbps

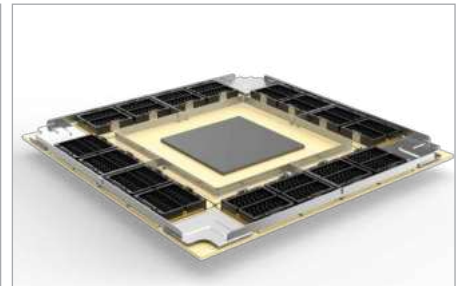
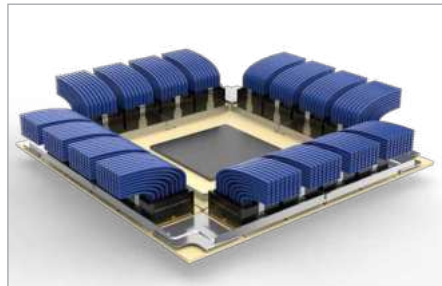
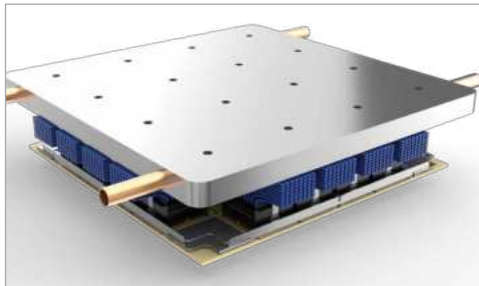
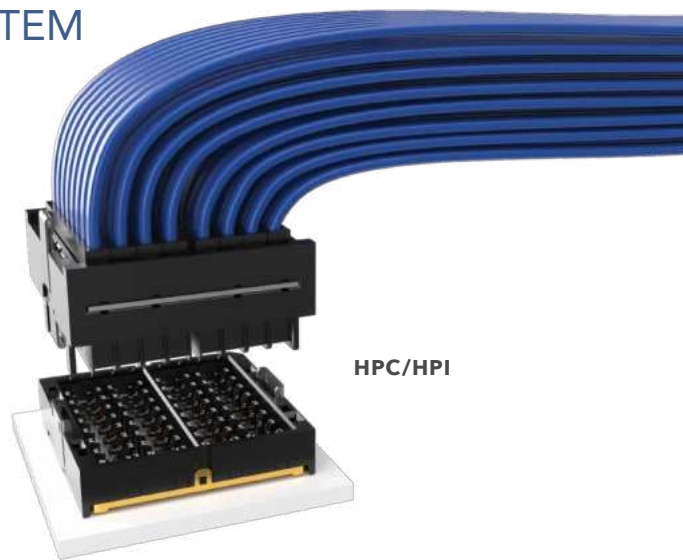

Ultra-high density solution for co-packaged applications.

# FLYOVER<sup>®</sup> BACKPLANE CABLES

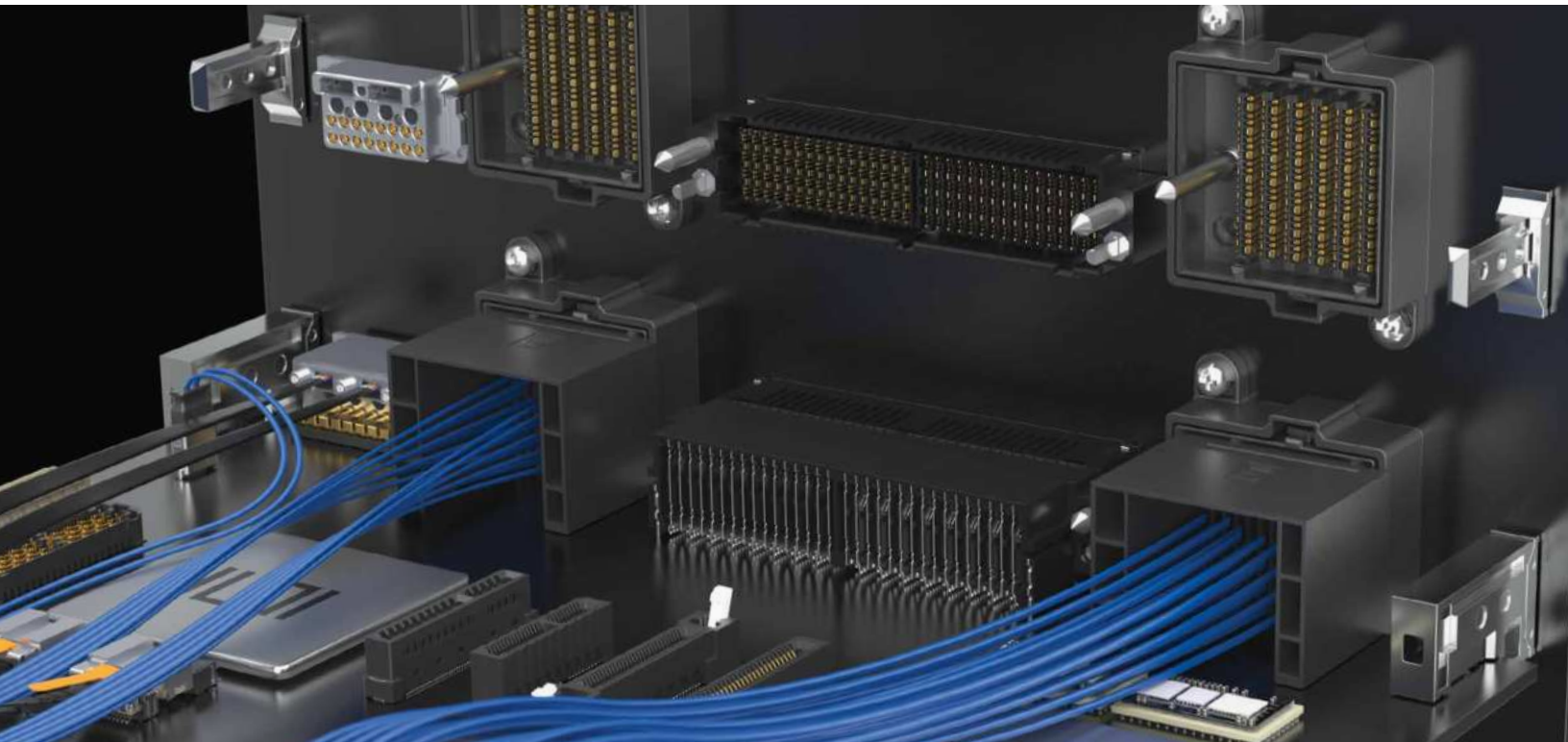

## NOVARAY<sup>®</sup> MICRO RUGGED BACKPLANE SYSTEM

- True 112 Gbps PAM4 signal integrity with Flyover<sup>®</sup> support
- Cable-to-board, cable-to-cable, board-to-board
- Configurable signal banks for design flexibility
- Offset footprint for optimal signal integrity performance
- Reliable two points of contact for stub free mating
- Large continuous ground blades between and surrounding the differential pairs eliminates resonances
- Optional guidance and keying for blind mate

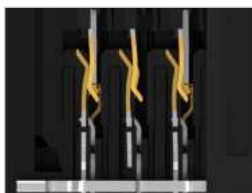

Precision Insert Molded Contact System



Solder Charge Termination for Higher Densities

PAM4  
**112**  
Gbps

**NOVARAY<sup>®</sup>**

Supports Blind Mate Applications

NVCF/NVBF/  
NVBM-RA

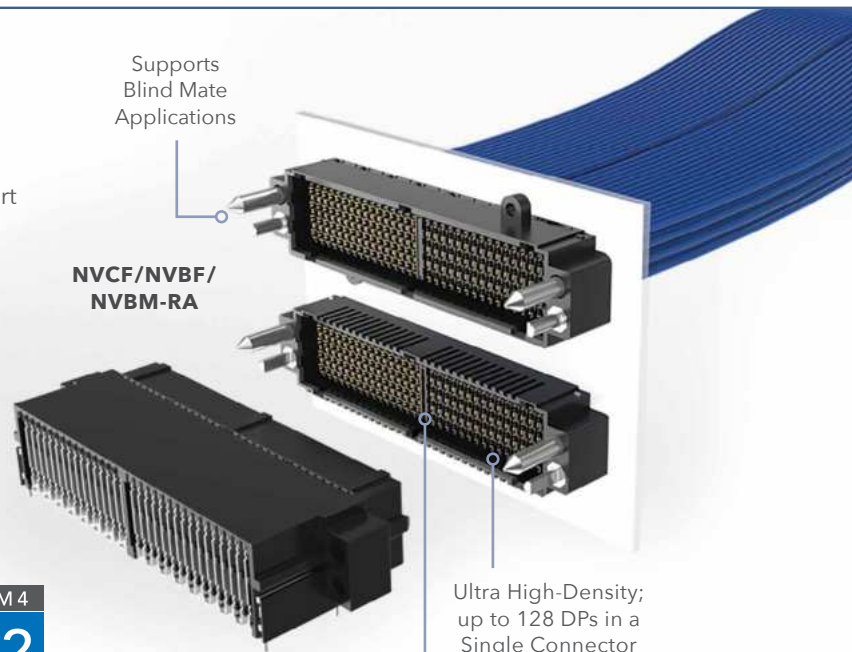

Ultra High-Density; up to 128 DPs in a Single Connector

Single-Ended or Differential Pair Wafers

# ExaMAX® HIGH-SPEED BACKPLANE SYSTEM

- Cable-to-cable, cable-to-board, mid-board and panel applications
- Highly customizable with modular flexibility
- Reduced costs due to lower PCB layer counts
- 4 and 6 pairs; 4-16 columns
- Integrated guidance and keying options
- Multiple end 2 options available
- Evaluation Kit available, see page 27 or visit [samtec.com/kits](http://samtec.com/kits)

NRZ	PAM4
56	112
Gbps	Gbps

## ExaMAX®



**EBCF/EBDM-RA**

Cable-to-DMO  
(Direct Mate Orthogonal)

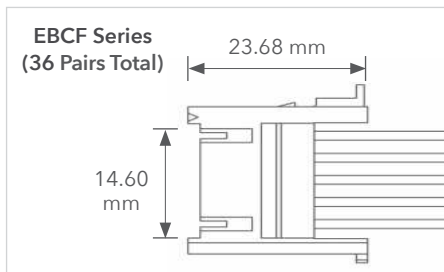

ExaMAX® I/O Cable System also available (see page 9)



Roadmap: 8 Pairs for Greater Design Flexibility

Designed for Blind-Mate Systems

Two Reliable Points of Contact with a 2.4 mm Wipe

Staggered Differential Pairs Provide Higher Data Rates

Industry's Lowest Mating Force with Excellent Contact Normal Force

**EBTF-RA**

**EBCB**

**EBCM**

**EBCF**

30 and 34 AWG Ultra Low Skew Twinax Cable Supports Various Cable Lengths

Vertical and Right-Angle

Wafer Design Increases Isolation for Reduced Crosstalk and Includes One Sideband Signal per Column

# HIGH-SPEED CABLE ASSEMBLIES

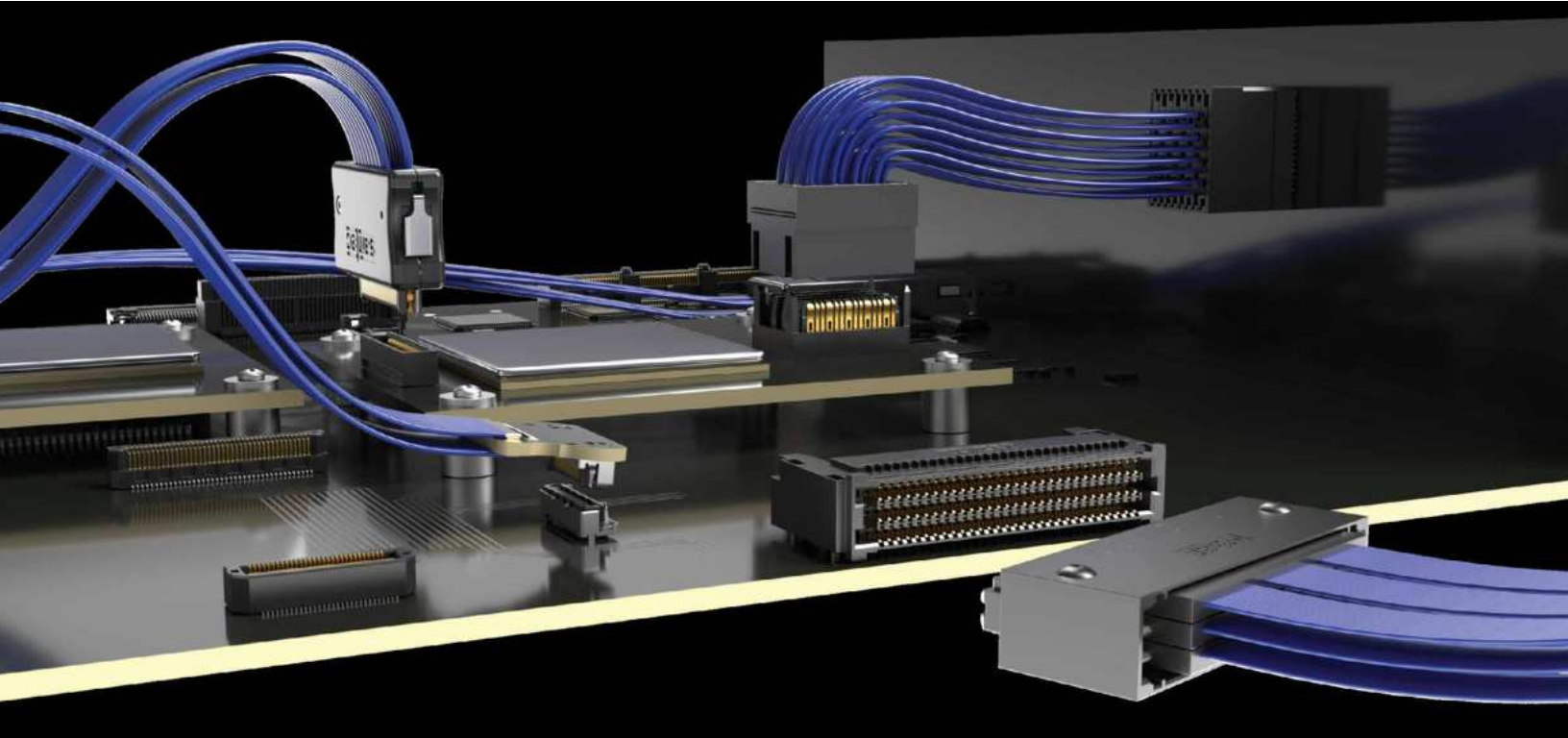

14  
Gbps

## MICRO COAX & TWINAX CABLE ASSEMBLIES

- Ability to mix-and-match end options for application-specific requirements with extensive customizing capabilities
- Single-ended 50  $\Omega$  & differential 100  $\Omega$  standards
- Rugged features and options including strain relief, plastic housings, screw downs, latches, locks, etc.
- Many non-cataloged standards available including 75  $\Omega$  micro coax and high-density twinax solutions



EYE<sup>®</sup>  
SPEED  
CABLE

## EYE SPEED<sup>®</sup> CABLE TECHNOLOGY

- Excellent signal integrity performance with individual copper serve or braid shielding
- Stranded conductor for small bend radii and dynamic high flexing cycle applications
- Cost-effective ribbonizing eliminates discrete wires
- 26-38 AWG coax and twinax construction; 20  $\Omega$ , 50  $\Omega$ , 85  $\Omega$  & 100  $\Omega$

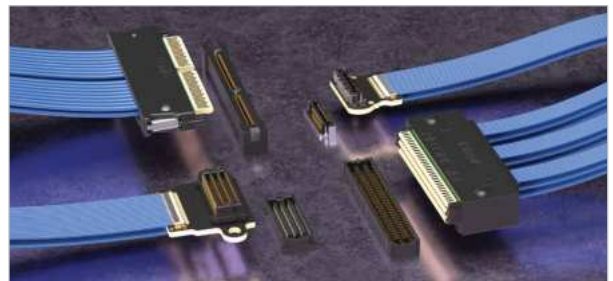

Samtec's Eye Speed<sup>®</sup> cable supports a wide variety of assemblies and applications

## HIGH-DENSITY ASSEMBLIES

- 1.27 mm (SEAC) and 0.80 mm pitch (ESCA)
- 34 or 36 AWG coax; 32 AWG twinax
- Mates with SEARAY™ and SEARAY™ 0.80 mm arrays
- Optional rugged latching



## GROUND PLANE ASSEMBLIES

- Integral power/ground plane
- 34 and 38 AWG coax; 30 AWG twinax
- 0.50 mm (HQCD/HQDP) and 0.80 mm pitch (EQCD/EQDP/EQRD)
- Mates with Q Series® and Q Rate® connectors

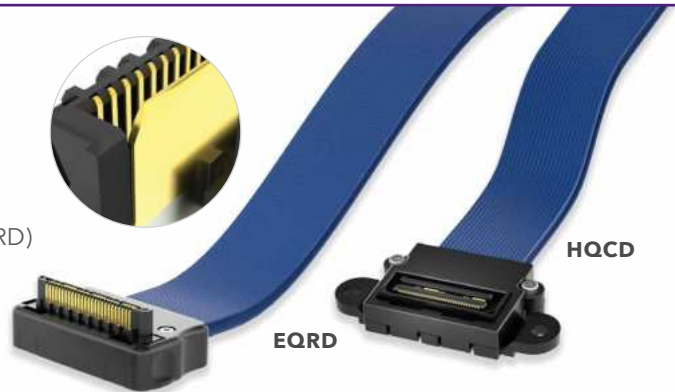

## EDGE CARD ASSEMBLIES

- 30 AWG twinax (ECDP); mates with Generate™ 0.80 mm pitch edge cards (HSEC8)
- PCI Express® twinax assemblies support 3.0/4.0/5.0 data transfer rates (PCIEC)
- FireFly™ copper available as standard (14 Gbps), optimized (56 Gbps PAM4) and PCIe® 4.0; Evaluation Kit available, see page 27 or visit [samtec.com/kits](http://samtec.com/kits)
- 34 AWG ultra low skew twinax (FEDP); mates with 0.50 mm pitch edge card (FCDP)



## HIGH-SPEED ASSEMBLIES

- Ultra-micro hermaphroditic Razor Beam™ coax assemblies with rugged shielding (HLCD)
- 0.80 mm pitch Edge Rate® coax and twinax assemblies (ERCD, ERDP)
- 38 AWG coax & 30 AWG twinax assemblies



# HIGH-SPEED CABLE

## DESIGN FLEXIBILITY



ANY  
high-speed  
connector

ANY  
break-out  
configuration

ANY  
high-speed  
precision cable

... to create a solution for  
any specific application.

HDR@samtec.com



Visit [samtec.com/custom](https://www.samtec.com/custom) for additional information.

## WILLINGNESS, SUPPORT & EXPERTISE

### Industry-Leading Customer Service

- Quotes and samples in 24 hours
- Prototype and processing assistance
- Dedicated Application Specific Product engineers and technicians

### Flexible, In-House Manufacturing

- Global Operations, including multiple cable fabrication & assembly facilities
- Quick-turn samples and prototypes
- Custom & modified product support

### Signal Integrity Expertise

- Industry-leading engineering support for high-performance system design
- Full system optimization assistance, including simulation, testing, analysis and evaluation

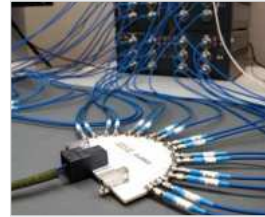
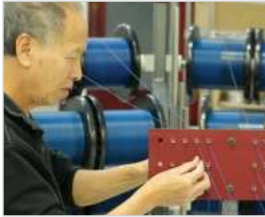

## CUSTOMS & EXPRESS MODIFICATIONS

Samtec is able to support completely new and/or custom designs, as well as common simple modifications to cable assemblies and board-to-board products - often with low or no NRE charges, short lead times, quick-turn samples, and low or no MOQ's. Capabilities include:

- Contacts
- Bodies
- Stamping
- Ruggedizing features
- Wiring
- Molding
- Plating
- Polarization
- Packaging
- Labeling
- Ink printing
- Shielding modifications



Double-ended micro coax cable assembly with two panel mount ground plane connectors

Rugged, high-speed Edge Rate® cable assembly with custom signal mapping to edge card

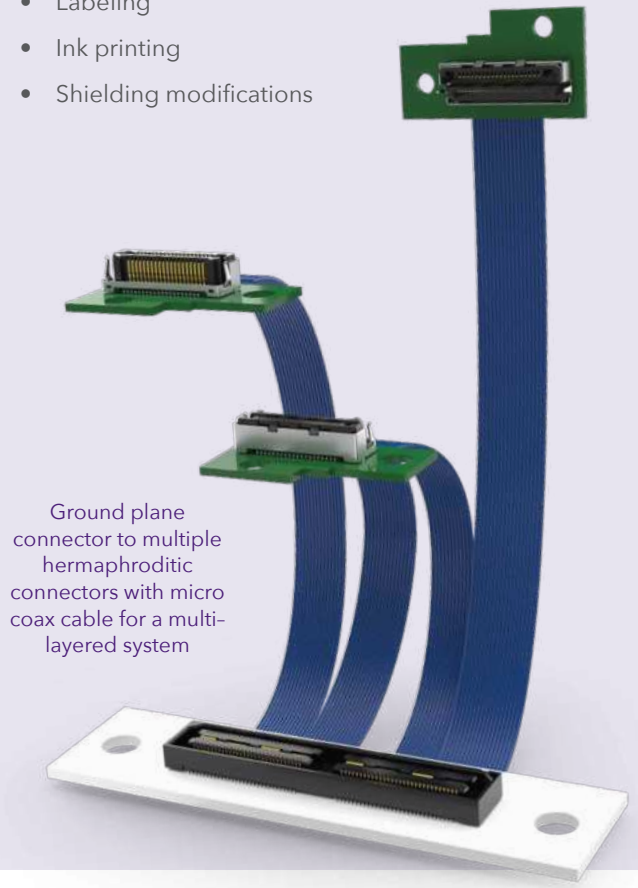

Ground plane connector to multiple hermaphroditic connectors with micro coax cable for a multi-layered system

# EYE SPEED® CABLE TECHNOLOGY



## ULTRA LOW SKEW TWINAX CABLE

Samtec's proprietary Eye Speed® co-extruded twinax cable technology eliminates the performance limitations and inconsistencies of individually extruded dielectric twinax cabling, improving signal integrity, bandwidth and reach for high-performance system architectures.

- Tight coupling between signal conductors
- Improved bandwidth (28-112+ Gbps) and reach
- Improved signal integrity and eye pattern opening
- Low skew (< 3.5 ps/meter) over extended lengths
- Supports Samtec Flyover® technology

### Micro Cellular Dielectric Extrusion

- Critical dimensions measured at every dielectric spool
- Inline laser and CAPAC devices for capacitance monitoring and diameter control
- In-process stats summary sheet for Cpk acceptance

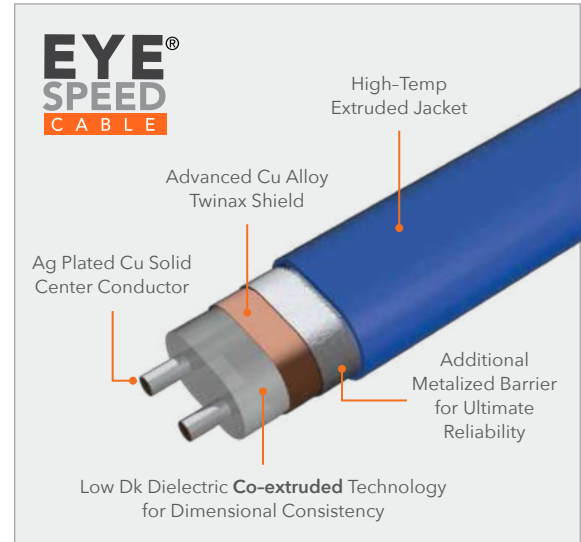

Eye Speed® Ultra Low Skew Twinax			28 AWG	30 AWG	32 AWG	34 AWG	36 AWG
Nominal Performance Specifications							
14 GHz (28G NRZ/ 56G PAM4)	0.25 m	IL (dB)	-1.0	-1.2	-1.5	-1.8	-2.2
	1.00 m		-3.9	-4.7	-5.9	-7.2	-8.7
28 GHz (56G NRZ/ 112G PAM4)	0.25 m		-1.5	-1.8	-2.2	-2.6	-3.2
	1.00 m		-6.0	-7.0	-8.7	-10.6	-12.7
Density/Flexibility			Good	Good	Better	Best	Best

\* Eye Speed® Ultra Low Skew Twinax Cable is available in engineered impedance configurations of 85 Ω, 92 Ω and 100 Ω.

## THINAX™ ULTRA PERFORMANCE TWINAX CABLE

- 40% smaller cross-sectional area
- 112 Gbps PAM4 performance
- Taped jacket miniaturizes the cable to match smaller, more dense connectors
- Allows for a smaller pitch within a row
- Achieving a smaller row-to-row pitch is dependent upon stack-up and BOR; customizable per application needs

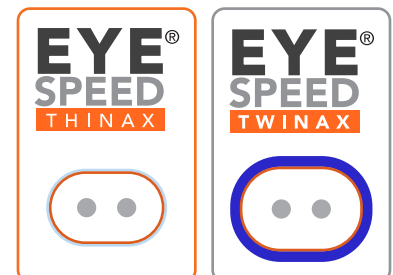

## DIRECT ATTACH CABLE

- High-density contacts directly soldered to the Eye Speed® ultra low skew twinax cable
- Improved signal integrity by eliminating the transition board and its variability
- Achieves tighter tolerances

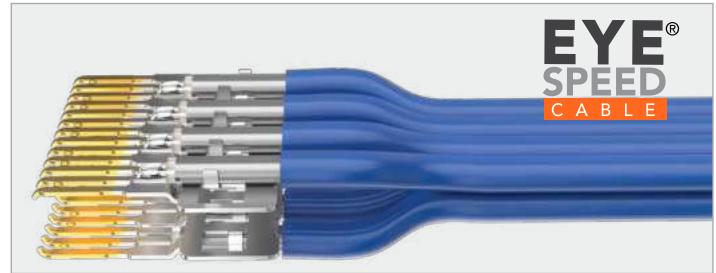

## MICRO COAX CABLE

- Foaming introduces air voids for signal to travel faster
- Solid extrusion of foamed dielectric provides a constant and more durable construction
- Lighter weight and smaller size with higher bandwidth capabilities at longer lengths
- 26 - 38 AWG cable available
- Choice of signal conductor, shield and FEP dielectric to meet performance and cost specifications

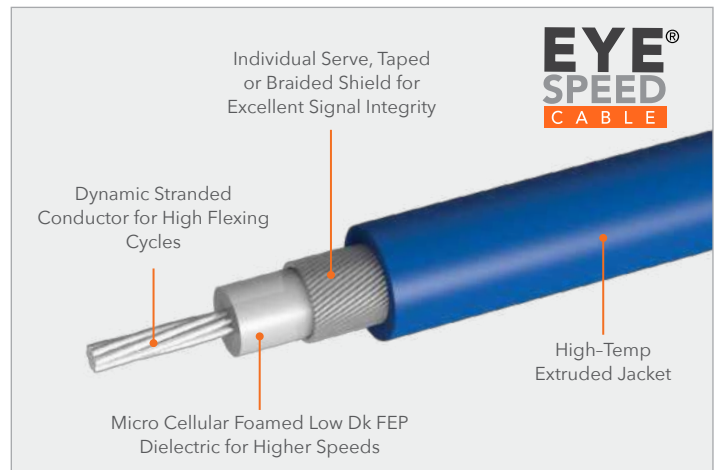

## DYNAMIC TESTING

Samtec Eye Speed® Ultra Low Skew Twinax cable underwent Dynamic Insertion and Return Loss testing, proving the cable to be rugged with stable electrical performance after 250 flex/bend cycles.

This arduous flex and bend test determined that the performance of Samtec Eye Speed® ultra low skew twinax is essentially indistinguishable from the original raw, unbent cable.

Ultra low skew twinax provides the lowest insertion loss in the industry, controlled performance across temperature, and robust insertion loss in any assembly and operation environment. Contact [HDR@samtec.com](mailto:HDR@samtec.com) for higher cycle results.

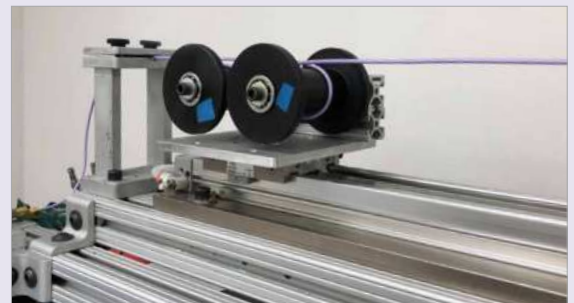

Six feet of ultra low skew twinax cable on mandrels was coiled/uncoiled moving back and forth on a slide at a rate of 20-25 cycles per minute.

## CABLE MANAGEMENT

- Samtec works with system architects in the early stages to optimize the architecture for cable management while keeping signal integrity and thermals in mind
- Complimentary service using mockups with accurate cable lengths
- Minimize number of SKUs within one system
- Minimize pressure drop



# ADVANCED OPTICAL SYSTEMS



## FIREFLY™ MICRO FLYOVER SYSTEM™ samtec.com/firefly

- Designed for flexibility, optical (ECUO) for greater distances and copper (ECUE; page 17) for cost optimization
- Industry leading miniature footprint allows for higher density close to the data source
- x4 and x12 configurations
- PCIe®-Over-Fiber supports 3.0/4.0 data rates for low latency, power savings and guaranteed transmission
- -40 °C to +85 °C extended temperature system (ETUO) for military, aerospace and industrial applications
- Extreme Environment FireFly™ sealed and Parylene-Coated for exposed applications (ETMO)
- Supports data center, HPC and FPGA protocols, including Ethernet, InfiniBand™, Fibre Channel, Aurora and PCIe®
- Multiple end options available: MTP®, MXC®, MT, Glenair® Series 79, VITA 66.X and other common interfaces
- Development Kit available, see page 27 or visit [samtec.com/kits](http://samtec.com/kits)

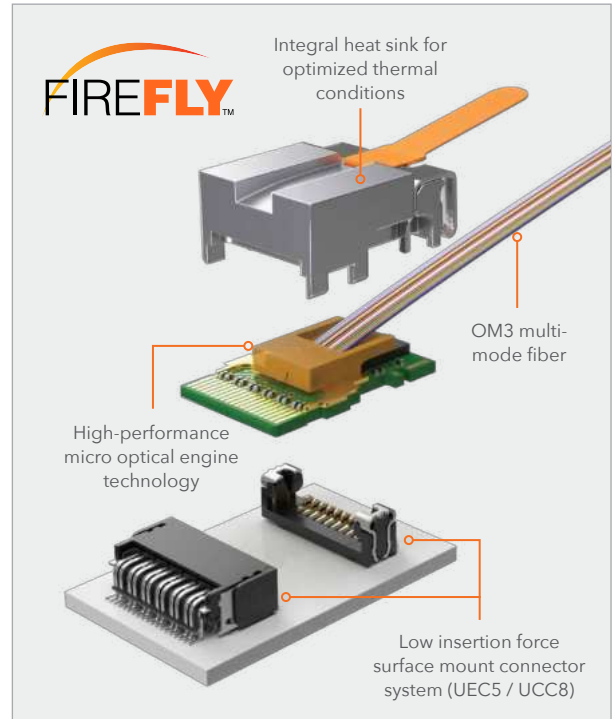

PCIe®-Over-Fiber Adaptor Card (PCOA), available in x4, x8 or x16 configurations; supports 3.0/4.0 platforms and transparent or non-transparent bridging

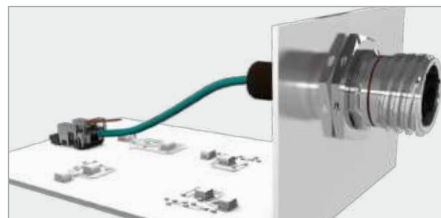

Extended Temp FireFly™ (ETUO) with Amphenol® Aerospace's bulkhead interconnects (MT38999) for rugged optical solutions



Glenair® Series 79 MT connector is an End 2 option featuring a miniature form factor and shielding; ideal for mil/aero and industrial applications

ECUO		PCUO		ETUO		PCOA	
FireFly™ Optical							
14 Gbps	x4 x12	25 Gbps	x4 x12	PCIe®-Over-Fiber			
				8 Gbps	PCIe® 3.0 x4 PCIe® 3.0 x8 PCIe® 3.0 x16	10 Gbps	x4, x12
				16 Gbps	PCIe® 4.0 x4 PCIe® 4.0 x8 PCIe® 4.0 x16	25 Gbps	x4
Extended Temp FireFly™							
PCIe®-Over-Fiber 3.0/4.0 Adaptor Card with FireFly™							

MTP® and MXC® are registered trademarks of US Conec Ltd. Amphenol® is a registered trademark of Amphenol Corp.

## FIREHAWK™ RUGGEDIZED OPTICAL TRANSCEIVERS

samtec.com/firehawk

- Chip Scale Package (CSP) with the industry's smallest footprint and lowest profile, weighing less than 0.4 grams
- FireHawk™ for Mil/Aero with an integrated microcontroller to automate key functions (CSPO)
- FireHawk™ for Space designed to withstand the impacts of radiation without the need for a microcontroller (CSSO)
- Extreme performance with up to 40 Gbps transfer rate
- 10G x 4 data rate (10 Mbps to 10 Gbps per channel)
- Rugged BGA board attach withstands high shock and vibration
- -40 °C to +85 °C extreme temperature range (+95 °C available)
- RVCON® optical cables are removable and replaceable for repair or reconfiguration
- Development Kit available, see page 27 or visit [samtec.com/kits](http://samtec.com/kits)
- Roadmap: 25G x 4 system (up to 25 Gbps per channel) in the same 10G connector footprint

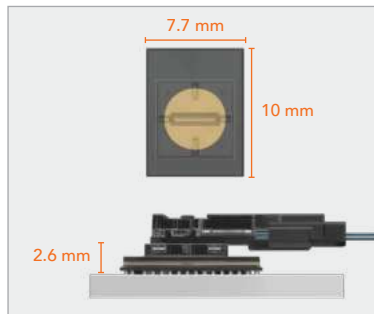

Ultra-compact, SWaP-optimized (Size, Weight and Power)

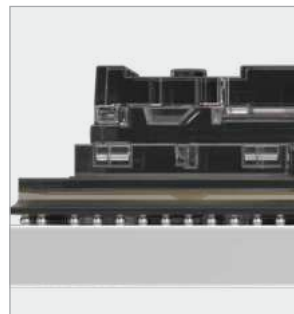

SMT reflow solderable with standard pick-and-place pad

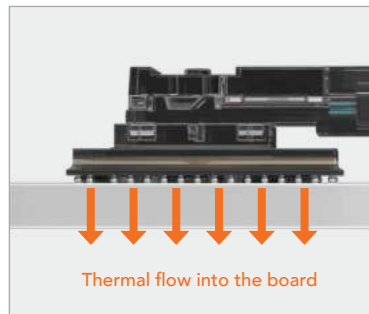

Direct mount to the PCB provides shortest possible thermal path

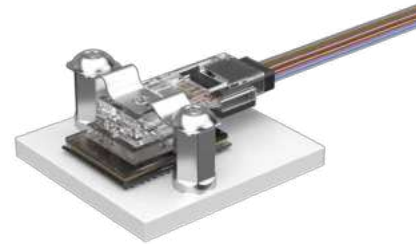

## HALO™ NEXT GEN OPTICAL

- Capable of up to 112 Gbps PAM4 per lane
- Up to 16 channels (8 channel bidirectional)
- Low 6 mm profile with a 2-piece contact system
- Designed to withstand high shock and vibration
- Features a low center of gravity for a stable connection to the board
- Optically pluggable for easy replacement and increased uptime

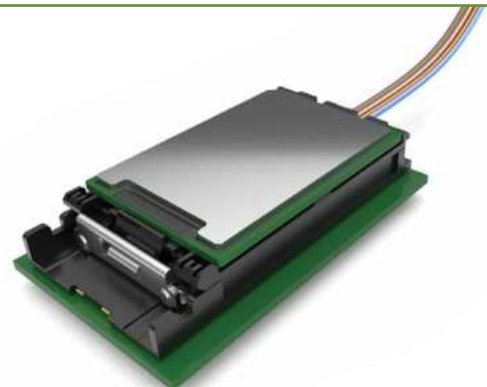

# HIGH-PERFORMANCE RF SOLUTIONS



## BULLS EYE® HIGH-PERFORMANCE TEST TO 90 GHz

- High-density, space-saving design that enables smaller evaluation boards and shorter trace lengths in test and measurement applications to 90 GHz
- Compression mounts to the board for placement directly adjacent to the SerDes being characterized
- Solderless design improves cost and is easy to use within a lab setting
- End 2 connection to instrumentation: 1.00 mm, 1.85 mm, 2.40 mm or 2.92 mm
- Single or double row
- Complete list of applications: SerDes characterization, clock/data recovery (CDR), mmWave radar, automated test equipment, FR2 5G networks
- Evaluation Kits available, see page 27 or visit [samtec.com/kits](http://samtec.com/kits)



DC TO  
**90**  
GHz

**BULLSEYE®**  
TEST POINT SYSTEM

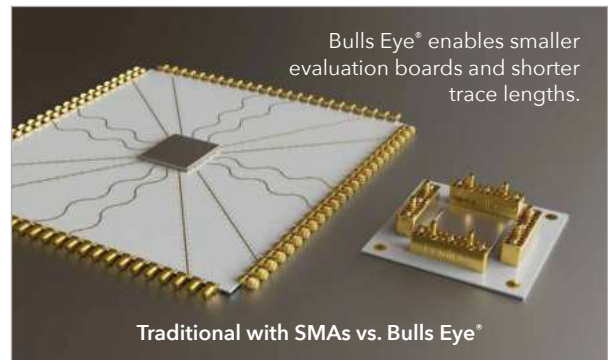

Frequency		90 GHz	70 GHz	50 GHz
Samtec Series		BE90A	BE70A	BE40A
Connection to Instrumentation		1.00 mm	1.85 mm	2.40 mm (50 GHz) 2.92 mm (40 GHz)
Block Options	No. of Rows	Single or Double		Double Row
	No. of Positions	1x: 2, 4, 8, 12 2x: 4, 8, 12, 16	1x: 2, 4, 8, 12 2x: 3, 4, 6, 8, 10, 12, 14, 16	2x: 3, 4, 6, 8, 10, 12, 14, 16

Test Assembly	BE90A	BE70A	BE40A
SerDes Characterization	PAM4 <b>224</b> Gbps	PAM4 <b>112</b> Gbps	PAM4 <b>56</b> Gbps

## HIGH-SPEED TEST CABLES

- Breakout test cables with RF connectors
- Capable of supporting PCIe® 4.0 and 5.0 (PCRF-G4/-G5)
- Capable of supporting 56 Gbps PAM4 (GC6-RF)

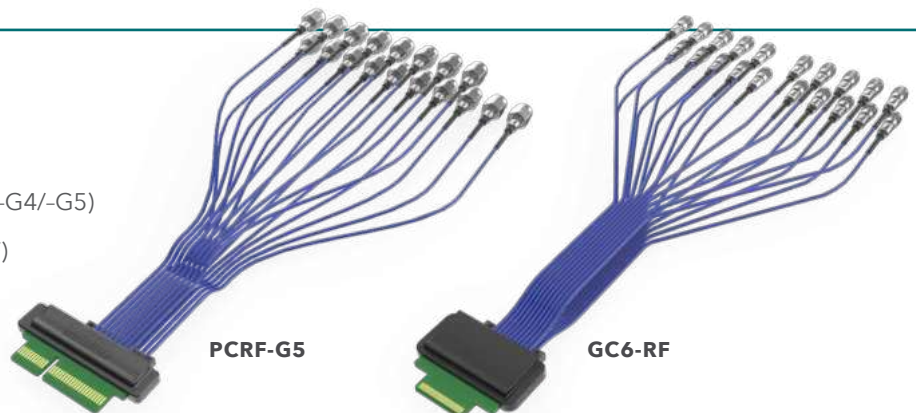

## PRECISION RF CABLE ASSEMBLIES & CONNECTORS

- High-frequency, microwave/millimeter wave solutions to 110 GHz
- Cable assemblies, cable connectors & board level connectors
- Variety of interfaces: 1.00 mm, 1.35 mm, 1.85 mm, 2.40 mm, 2.92 mm, 3.50 mm, SSMA, SMP, SMPM, ganged SMPM, SMA, N Type, TNCA
- Magnum RF™ ganged SMPM for 40% greater density, less processing time and better positional alignment
- Low-loss microwave and millimeter wave cable from .047" to .277"
- Vertical or edge launch solderless compression mount board connectors for test and measurement applications
- Soldered push-on board connectors for high-density, blind-mate applications
- Between-series and in-series adaptors designed for well-performing VSWR



## NEXT GEN RF CABLE ASSEMBLIES

- Phase and insertion loss stable microwave/millimeter wave cables - **Orange is the New Cable!**
- Optimized coaxial structure to meet increased demands placed on the Aerospace, Defense, Datacom, Computer/Semi and Instrumentation markets
- Cable construction designed to support extended frequency ranges for emerging applications
- Next gen cable provides improved IL performance vs. industry standard cable at the extended frequency range
- Interface options include 1.00 mm, 1.35 mm, 1.85 mm, 2.40 mm, 2.92 mm, SMPM, SMP, SMA, N Type and TNCA

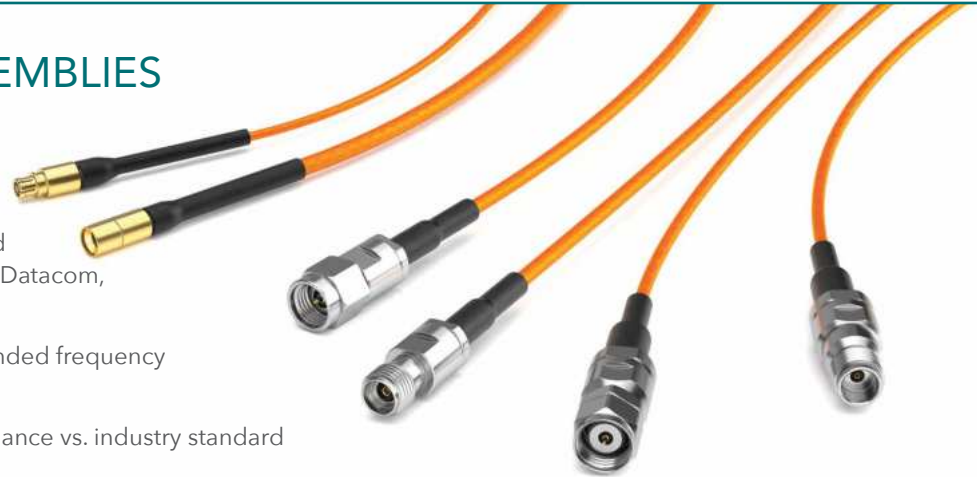

## FLEXIBLE WAVEGUIDE

- Innovative technology that is flexible, easier to use and lower cost, while also maintaining low insertion loss, versus traditional metallic rigid waveguides
- E-Band frequency range of 60 to 90 GHz in development
- Flexible cable construction with dynamic stability
- Less signal loss than standard microwave coax cable
- Ultra-small form factor with threaded coupling and stripline routing



# CABLE TECHNOLOGY & MANUFACTURING EXPERTISE

Samtec's state-of-the-art High-Speed Cable Plants provide industry-leading R&D and manufacturing of precision extruded micro coax and twinax cable, and next generation RF cable technology. Our priority is the development of differentiated products and technologies that address the existing and future challenges of bandwidth, reach, signal integrity, and phase stability demands.

## MANUFACTURING TECHNOLOGY

- World-class in-house expertise
- Internally developed proprietary processes
- Extensive customization capabilities
- Procurement and test of new materials
- Quick-turn design and manufacturing
- Unparalleled pricing and delivery

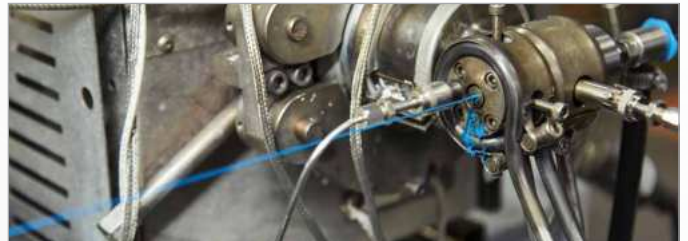

## NEXT GENERATION INNOVATION

- Real-time closed-loop control to adjust parameters
- Microcellular dielectric extrusion
- Co-extruded, low loss twinax cable
- Extreme density twinax cable
- Phase and insertion loss stable high frequency RF cable
- Halogen-free materials
- Thermal capabilities

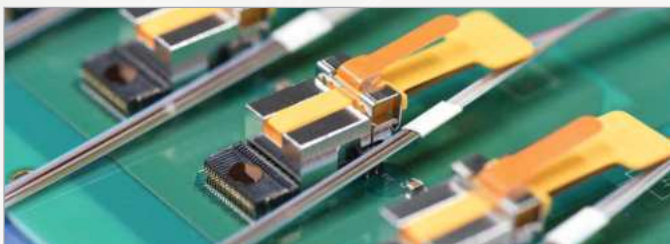
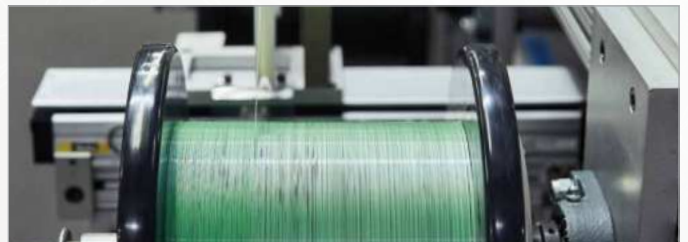

# EVALUATION & DEVELOPMENT KITS

Samtec Evaluation and Development Kits provide system designers and engineers easy-to-use platforms for testing many of Samtec's popular products, helping to simplify the design process and reduce time to market.

Each kit includes the evaluation platform, calibration board(s), technical documentation and test reports. Additionally, each kit is tested and verified by Samtec's signal integrity experts before customer delivery. Visit [samtec.com/kits](http://samtec.com/kits) or contact [kitsandboards@samtec.com](mailto:kitsandboards@samtec.com) for current availability.

## SIGNAL INTEGRITY EVALUATION KITS



AcceleRate® Flyover®  
Slim Cable System  
(ARC6/ARF6)



NovaRay® Flyover®  
Cable System  
(NVAC/NVAM-C)



Si-Fly™ Low Profile  
Cable System  
(CPC/CPI)



Flyover® QSFP  
Cable System  
(FQSFP to ARC6)



Flyover® QSFP  
Double Density Cable System  
(FQSFP-DD to NVAC/ARC6)



ExaMAX® Backplane  
Cable System  
(EBCM/EBTF-RA)



FireFly™ Copper  
Micro Flyover System™  
(ECUE/UEC5-2/UCC8)



Bulls Eye® 50 GHz  
High-Performance Test System  
(BE40A)



Bulls Eye® 70 GHz  
High-Performance Test System  
(BE70A)

## OPTICS KITS



25/28 Gbps FireFly™ FMC+ Kit



28 Gbps FireFly™ Kit

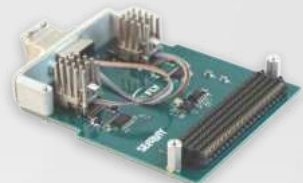

14 Gbps FireFly™ FMC Kit



10 Gbps FireHawk™ Kit

# SAMTEC SUDDEN SERVICE®



## UNMATCHED LEADTIMES | Deliveries in Days, Not Weeks

Optimized logistics and innovative programs, along with Samtec's unique infrastructure and flexibility, help expedite the ordering process and get parts delivered in the fastest most efficient way possible.

# Reserve™

This designation allows customers to **quickly and easily identify availability of over 200,000 of Samtec's most popular connectors and cables - guaranteed to ship in 1-day.**

Look for the **Reserve** badge throughout **samtec.com** to quickly determine if your part number is eligible, along with current availability, quantity breaks and pricing. Hundreds of part numbers are being added daily!



# 24HOUR SUDDEN SAMPLE™

**Free product samples, shipped in 24-hours** or less have been a cornerstone of **Samtec Sudden Service®** since the company was founded. Visit **samtec.com** to quickly request your sample.

# 2DAYS WORLD DIRECT™

**An innovative shipping program** that bridges the gap between manufacturing facilities and customers, allowing for manufacturing flexibility without increased costs, and with even faster lead-times. Contact **eCustomerService@samtec.com** to learn more.

## 24/7 WORLDWIDE ACCESS | The Industry's Service & Technology Leader

### Technical Support

Signal Integrity Group: **sig@samtec.com**

Application Support Group: **asg@samtec.com**

Interconnect Processing Group: **ipg@samtec.com**

### Supply Chain Support

MySamtec™ Real-Time Account Access: **account.samtec.com**

Personal Account Managers/CSRs: **eCustomerService@samtec.com**

Upfront, Aggressive 24-Hour Quotes: **ePricing@samtec.com**

## mySamtec™ | A Personalized Web Experience for Easy Ordering

Samtec's user-friendly eCommerce platform allows you to quickly and easily check product availability and pricing, as well as place and manage your orders online. Visit **account.samtec.com** to access your account.

## ONLINE TOOLS | Find, Design & Validate Your Solution

Quickly and easily find the right solution, whether you prefer to search by product name or characteristics, browse through pictures, or build an assembly by entering physical specifications.

### Picture Search

Browse through a highlight reel of Samtec's most popular products to find the ideal solution for your application, view specifications, check availability, order samples and more.



High-Speed Cable

QR Code

[samtec.com/picturesearch/high-speed-cable](https://samtec.com/picturesearch/high-speed-cable)

### Downloadable Resources

Samtec offers immediate and unlimited access to all the resources needed to select the right solution - from 3D models, prints and footprints, to test reports, white papers and much more. Visit [samtec.com](https://samtec.com) to start exploring.



### Solutionator®

Quickly build mated connector sets or design full cable assemblies using a wide variety of user-defined search parameters and filters, view specs and order samples in Samtec's online design tools.

#### Solutionator HS CABLE



DESIGN IN A MINUTE

GET A MATED SET IN SECONDS

[samtec.com/cablebuilder](https://samtec.com/cablebuilder)

#### Solutionator HS BOARD TO BOARD



DESIGN IN A MINUTE

GET A MATED SET IN SECONDS

[samtec.com/hsb2b-solutionator](https://samtec.com/hsb2b-solutionator)

#### Solutionator RF CABLE



DESIGN IN A MINUTE

GET A MATED SET IN SECONDS

[samtec.com/rf-cablebuilder](https://samtec.com/rf-cablebuilder)

#### Solutionator FLEX STACKING



DESIGN IN A MINUTE

GET A MATED SET IN SECONDS

[samtec.com/flex-solutionator](https://samtec.com/flex-solutionator)

#### Solutionator ACTIVE OPTICS

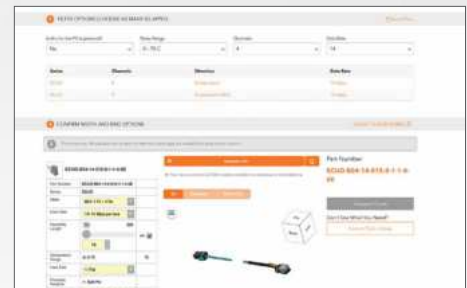

DESIGN IN A MINUTE

GET A MATED SET IN SECONDS

[samtec.com/optics-solutionator](https://samtec.com/optics-solutionator)

# INTEGRATION LEADS TO INNOVATION

Samtec's integrated business model facilitates high-level design and development of advanced interconnect systems and **TECHNOLOGIES**. Along with industry-leading expertise, this allows us to offer effective strategies and support for **optimizing the entire signal channel of high-performance systems**.

Samtec is structured like no other company in the interconnect industry. We work in a fully integrated capacity that enables true collaboration and results in uniquely innovative **PRODUCTS** because **our technology teams are not limited by the boundaries of traditional business units**.

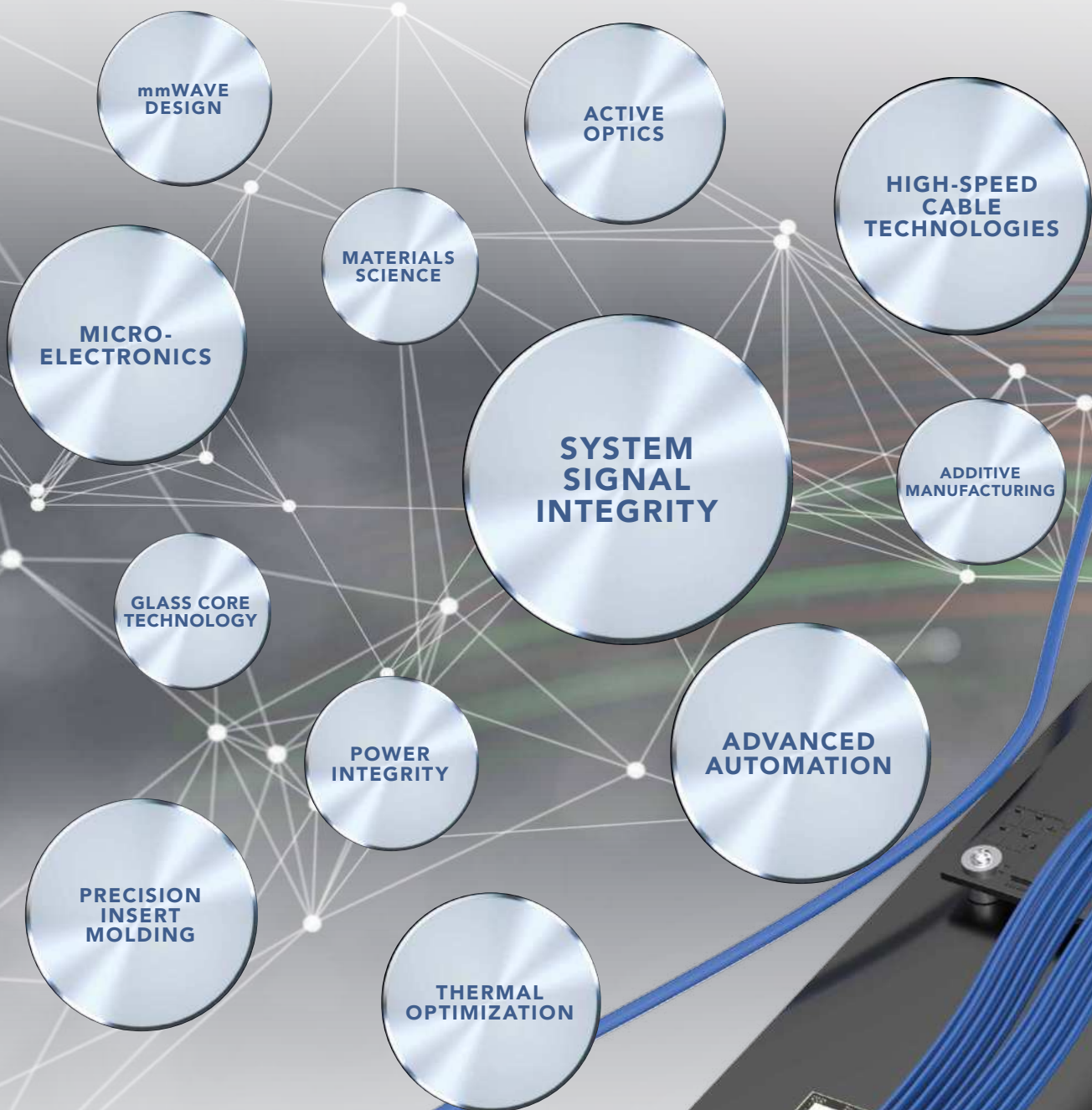

# SILICON-TO-SILICON™ SOLUTIONS

As bandwidth, scale and power requirements continue to challenge conventional engineering methods, Samtec strives to help **optimize the landscape of your entire system** - and develop solutions, together.

**Samtec's industry-leading signal integrity expertise**, full system optimization strategies, and innovative products and technologies help address the challenges of next gen data transmission for **a path to 224 Gbps and beyond**.

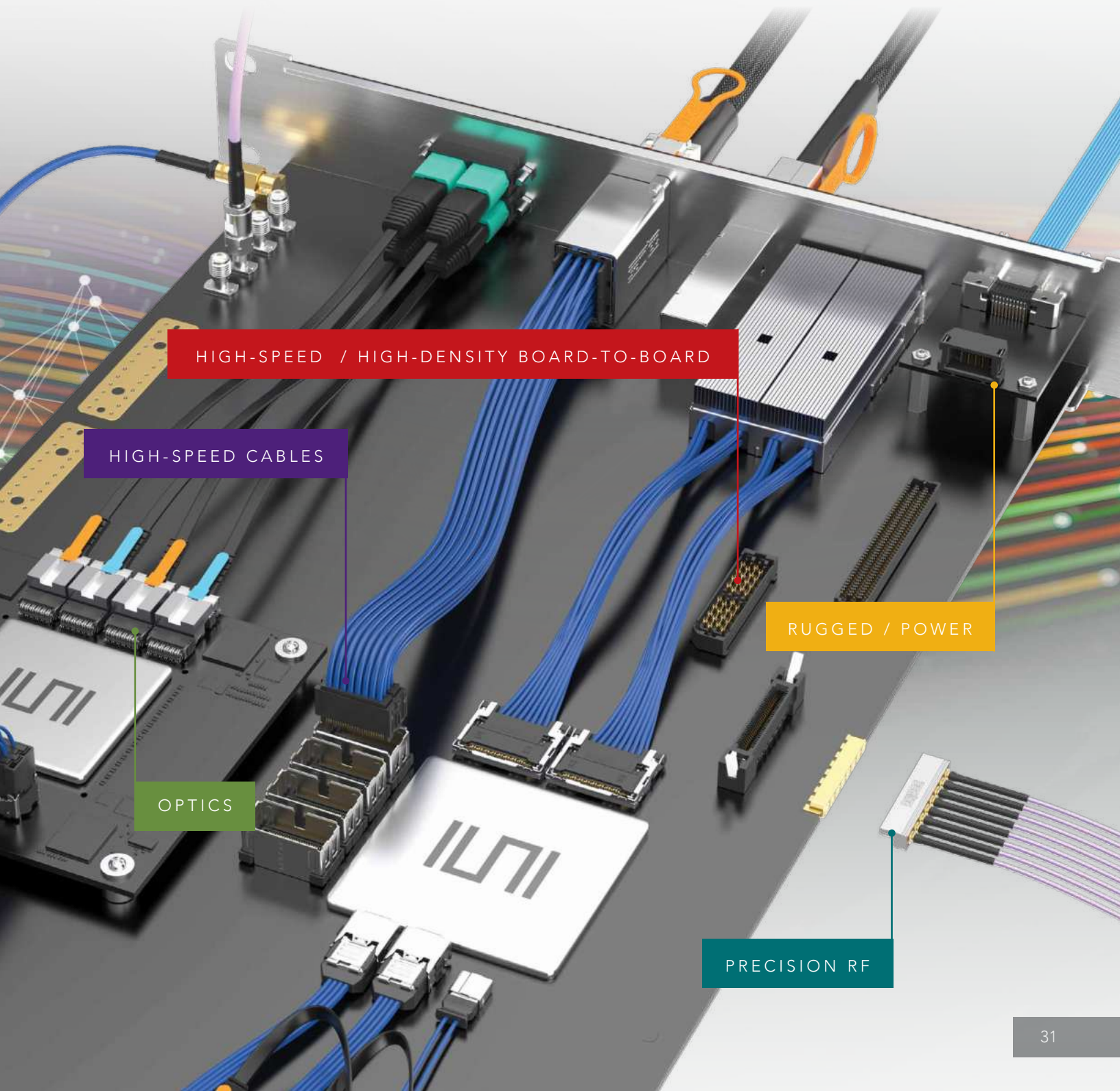

HIGH-SPEED / HIGH-DENSITY BOARD-TO-BOARD

HIGH-SPEED CABLES

RUGGED / POWER

OPTICS

PRECISION RF

# GLOBAL SUPPORT NETWORK



[www.samtec.com](http://www.samtec.com)

ISO-9001 and/or IATF 16949 Certified  
© JUNE 2023, SAMTEC INC.