

# Safety Solutions

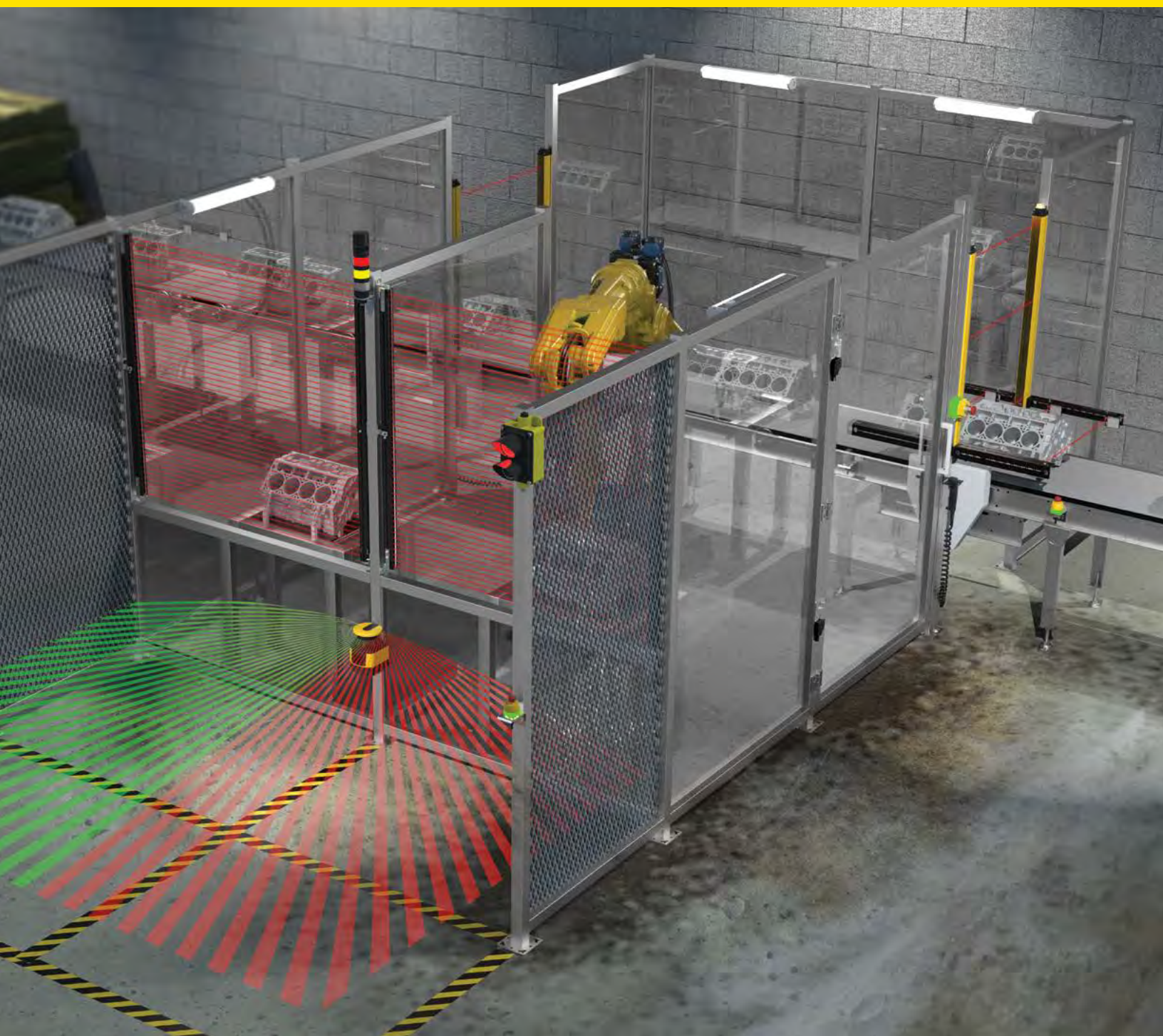



## Contents

Complete Safety Solutions from Banner .....	4
Network Technology Down to the Device Level .....	6
Banner In-Series Diagnostics (ISD).....	8

### Hand, Finger and Body Detection

Choosing a Safety Light Curtain.....	10
S4B Type 4 Heavy-Duty Light Curtains.....	12
EZ-SCREEN LS Type 4 Heavy-Duty Light Curtains .....	16
EZ-SCREEN LP Type 4 Light Curtains.....	20
EZ-SCREEN LP Type 4 Compact Light Curtains.....	22
EZ-SCREEN LS2 Type 2 Light Curtains.....	24
SGS Type 4 Safety Light Grids.....	26

### Area Detection

Choosing a Safety Scanner .....	30
Safety Scanner System .....	32
Safety Scanner Software .....	35
Safety Scanner Fixed Applications.....	36
Safety Scanner Mobile Applications.....	37

### Safety Relays and Controllers

Choosing a Relay and Controller.....	38
Safety Relays and Safety Controllers .....	40
In-Series Diagnostics Functionality .....	43
System Software.....	44
Safety Relay Models.....	46
Safety Controller Models.....	47

### Safety Switches

Choosing a Safety Switch.....	48
Safety Switches.....	50
Non-Contact RFID Safety Switches.....	52
Enabling Devices .....	53
Safety Switch Models.....	54

### Operator Controls

Choosing an Emergency Stop Device.....	58
E-Stop Device Models.....	60

# Complete Safety Solutions from Banner



## Safety Light Curtains

- Intuitive and easy-to-use and set up
- End-to-end sensing
- Heavy-duty aluminum housing and recessed window to avoid damage in harsh environments
- Highly visible alignment and diagnostic indicators
- IP69 hygienic models available for washdown environments
- Cascade capable models available
- See page 10



## Safety Controllers

- Up to eight expansion I/O modules can be added as your safety application grows or changes
- Configuration software is so simple that you will be programming in minutes
- Simulator functionality allows users to test their configurations without being connected to a controller
- Available with ISD, which provides an array of data including device status, voltage, temperature, RFID tag value, sensing distance, and more
- View and configure your controller remotely using Banner's network access feature
- See page 38



## Safety Laser Scanners

- Two-dimensional laser scanner with easy-to-use software
- Programming of irregular shaped warning and detection zones
- 275° scanning angle with selectable resolutions and 5.5 m range
- See page 30

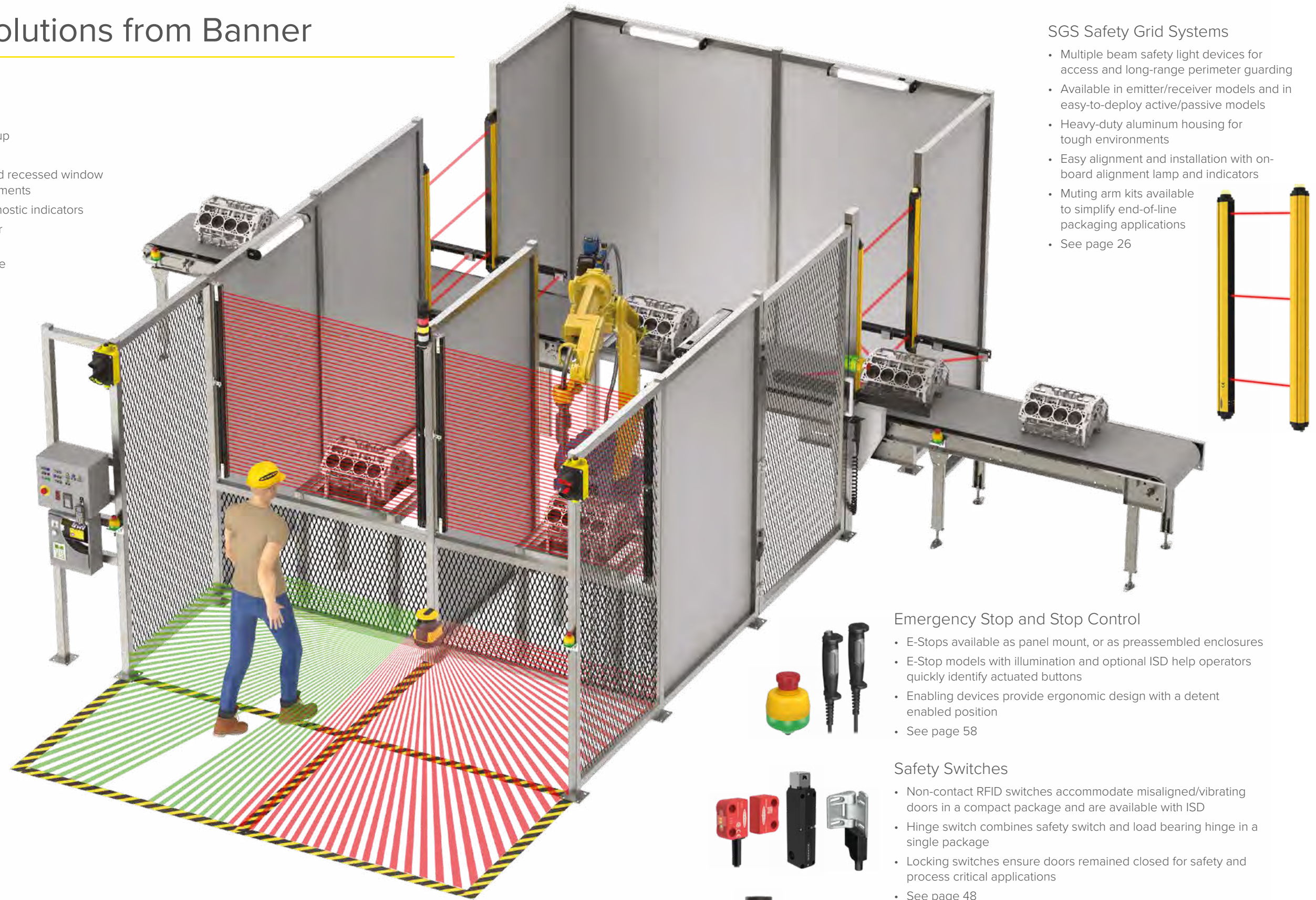

## SGS Safety Grid Systems

- Multiple beam safety light devices for access and long-range perimeter guarding
- Available in emitter/receiver models and in easy-to-deploy active/passive models
- Heavy-duty aluminum housing for tough environments
- Easy alignment and installation with on-board alignment lamp and indicators
- Muting arm kits available to simplify end-of-line packaging applications
- See page 26

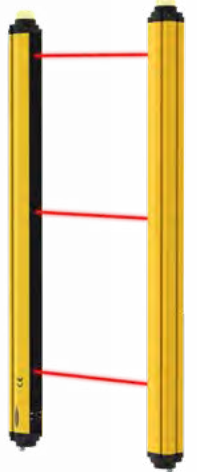

## Emergency Stop and Stop Control

- E-Stops available as panel mount, or as preassembled enclosures
- E-Stop models with illumination and optional ISD help operators quickly identify actuated buttons
- Enabling devices provide ergonomic design with a detent enabled position
- See page 58



## Safety Switches

- Non-contact RFID switches accommodate misaligned/vibrating doors in a compact package and are available with ISD
- Hinge switch combines safety switch and load bearing hinge in a single package
- Locking switches ensure doors remained closed for safety and process critical applications
- See page 48



## Lighting and Indication

- Preassembled and preconfigured multi-segment LED tower light indicators
- Programmable multicolor LED indicators, panel mount models available
- Pro Editor software offers a wide variety of color and animation options



# Network Technology Down to the Device Level

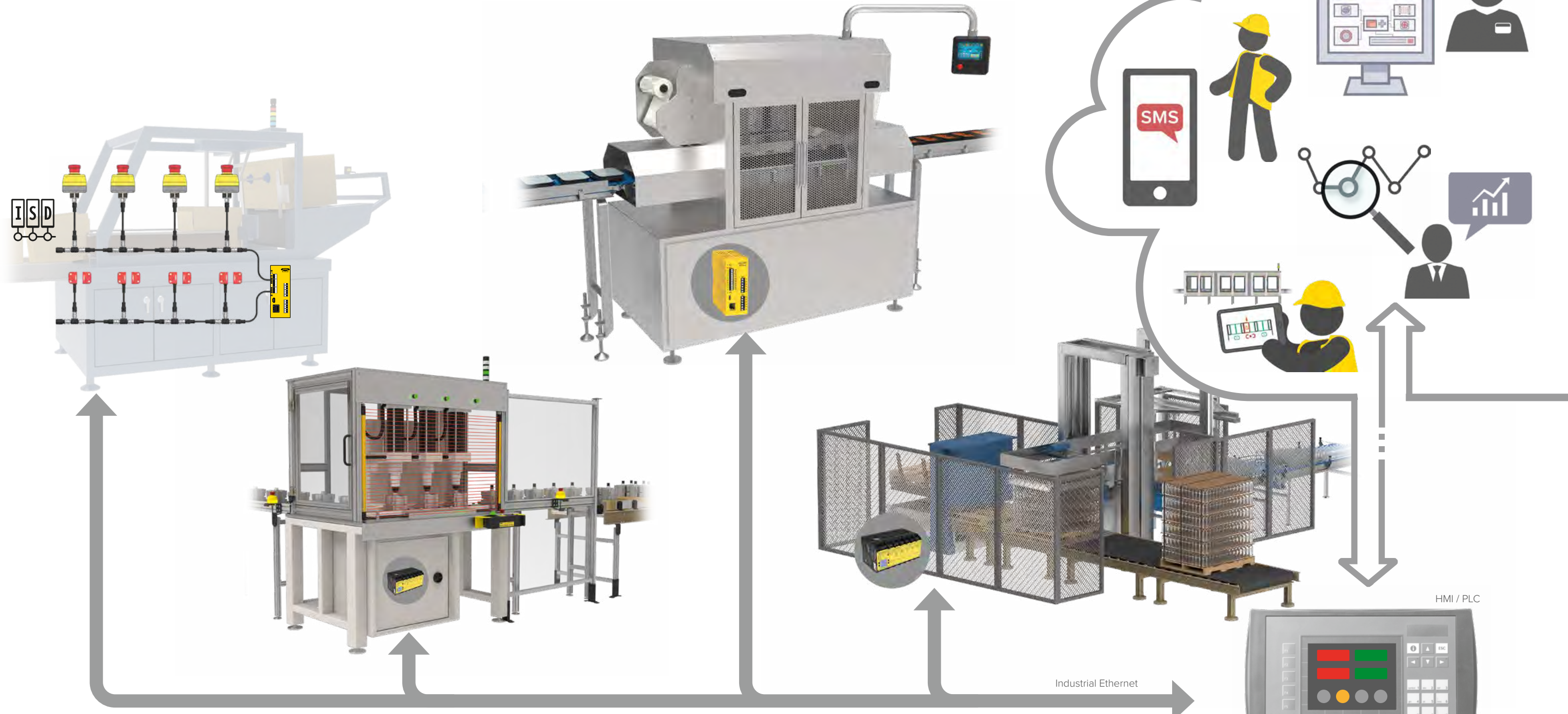

## Banner In-Series Diagnostics

- Up to 32 ISD devices connected with one in-series cable communicate directly with PLC/HMI
- ISD provides an array of data including device status, voltage, temperature, RFID tag value, sensing distance, and more

## Safety System Diagnostics

- Reduce downtime by quickly diagnosing safety events and displaying them on the HMI
- Prevent downtime with ISD preventive maintenance alerts

## Virtual Reset

- Eliminate physical button & wires
- Reset from touch screen HMI over Industrial Ethernet

EtherNet/IP

Modbus TCP/IP

PROFIBUS NET

EtherCAT

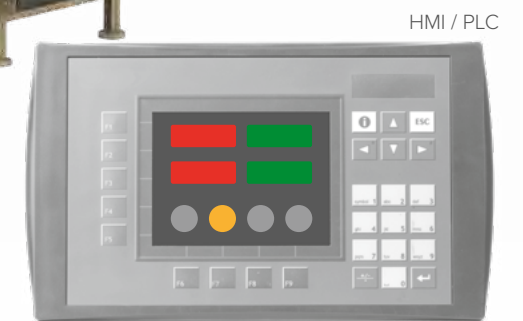

Intuitive setup and PLC integration

Free, easy-to-use PC software

- Export tag feature for easy tag creation in a PLC (patent pending)

# ISD Banner In-Series Diagnostics (ISD)

Easy-to-Implement Diagnostic Capabilities for Complex Safety Systems

In-Series Diagnostics allows connection of up to 32 devices with one in-series connection and communicate directly with the most commonly used PLCs.

When a safety event occurs the system receives an alert that includes information about which safety device tripped, making troubleshooting a breeze.

In-Series Diagnostics provides an array of additional data points for each in-series device used, including a unique tag value, internal temperature, voltage, and more, along with device-specific details such as the alignment and distance between a safety switch's sensor and actuator.

Additionally, the system sends warning alarms if devices are near to tripping, so issues can be addressed before your machine shuts down.



Cut Costs



Simplify Installation & Troubleshooting



Prevent & Reduce Downtime

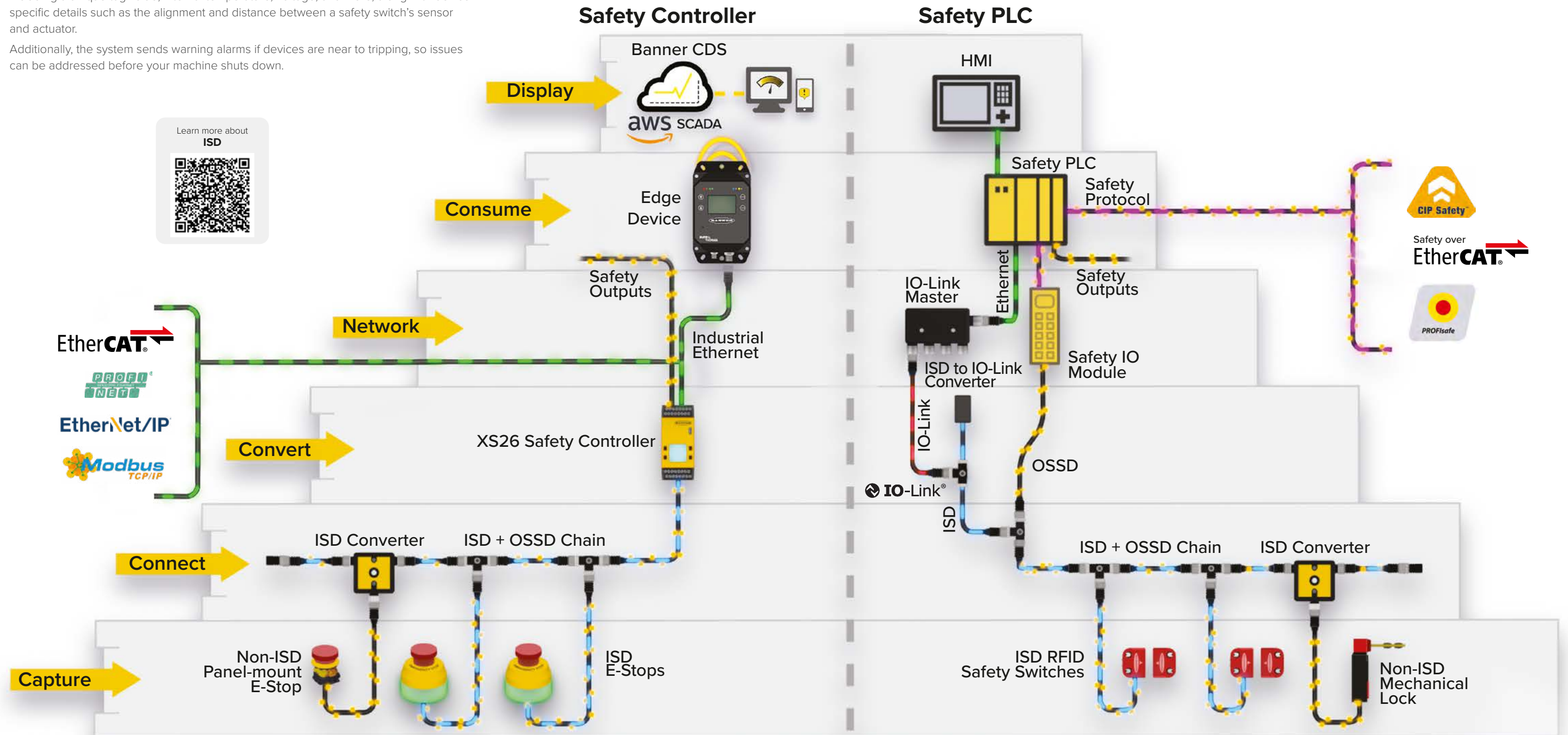

# Safety Light Curtain Selection Guide



**S4B**



**EZ-SCREEN LS**



**EZ-SCREEN 14/30**



**EZ-SCREEN LP**



**EZ-SCREEN LS2**



**SGS Grids**

	p. 12	p. 16	p. 20	
Type IEC 61496-1, -2	Type 4	Type 4	Type 4	
Safety Rating EN ISO 13849-1; IEC 61508; IEC 62061	Category 4 PL e; SIL3	Category 4 PL e; SIL3	Category 4 PL e; SIL3	
IP Rating	IP65	IP65, IP67, IP69K option	IP65	
Dimensions W x D (mm)	38 x 38	36 x 45	36 x 45	
Resolution (mm)	14, 30	14, 23, 40	14	30
Max Sensing Range (m)	12	12	6	18
Defined Area (mm)	14 mm: 300 to 1200 30 mm: 300 to 1800	14 mm: 280 to 1820 23 mm: 280 to 2380 40 mm: 280 to 1820	150 to 1800	150 to 2400
Increments (mm)	150	70	150	

p. 22
Type 4
Category 4 PL e; SIL3
IP54, IP65
28 x 26
14, 25
Basic: 4 Standard: 7
Basic: 270, 410, 550, 690 Standard: 270 to 1250
Standard: 140

p. 24
Type 2
Category 2 PL c
IP65
25 x 32
30
15
150 to 1800
150

p. 26
Type 4
Category 4 PL e; SIL3
IP65
52 x 56.9
300, 400, 500
Standard: 30 Long Distance: 60
500 to 1200
2, 3, 4 Beams

Functions			
Hand Detection	✓	✓	✓
Finger Detection	✓	✓	✓
Body Detection			
Cascade	✓	SLLC	SLSC
Scan Codes	✓	✓	✓
Fixed Blanking		✓	✓
Reduced Resolution			✓
EDM	✓	✓	✓
Reset			✓
Integrated Muting			
LED on Top		Accessory	

✓
✓
SLPC
✓
✓
✓
✓
✓
✓
✓

✓
✓
✓

✓
✓
✓
✓
✓
✓

# S4B Type 4 Heavy-Duty Light Curtains

Designed for a broad range of applications, the next generation of safety light curtains has essential features including remote indication for predictive maintenance.

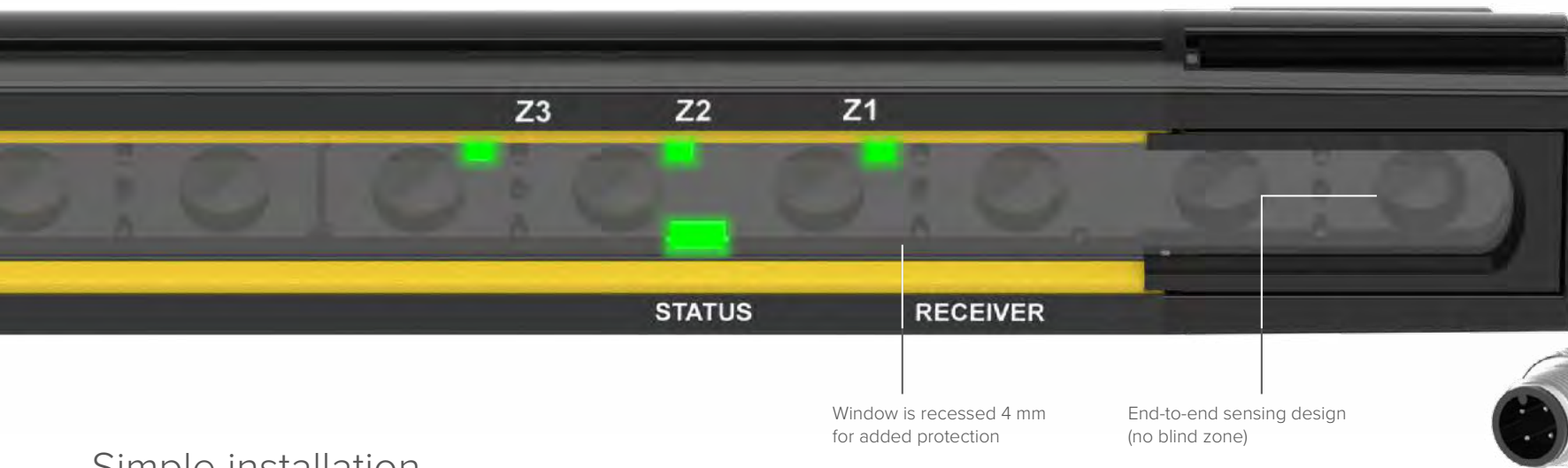

Window is recessed 4 mm for added protection  
End-to-end sensing design (no blind zone)

## Prevent Downtime

Yellow indicates a weak signal due to a dirty lens. A weak beam strength output is sent via pin 5 to a PLC or HMI alerting operators to preventive maintenance needs.



**Reliable Finger Detection**  
The S4B is available with 14-millimeter resolution for reliable finger detection



**Reliable Hand Detection**  
The S4B is available with 30-millimeter resolution for reliable hand detection

## Simple installation

The S4B gives you more flexibility when deciding how to mount light curtains on your machine. Choose from either center-mount brackets or end cap brackets, both offering up to 15 degrees of freedom to align the emitter and receiver. Once the light curtains are mounted, alignment is further simplified with the onboard alignment zone indicators as shown below.

### Alignment Zone Indicators

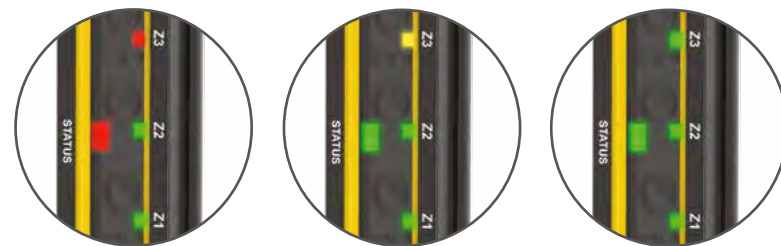

**Misaligned**  
Red indicates a loss of signal due to a blocked beam or significant misalignment

**Weak**  
Yellow indicates a weak signal due to a slight misalignment

**Aligned**  
Green indicates a strong signal, proper alignment, and clear of obstruction



Center mount brackets



End cap mounting brackets

### Intuitive Setup and Swap-out

Select and save scan code setting without a PC for easy setup and swap-out

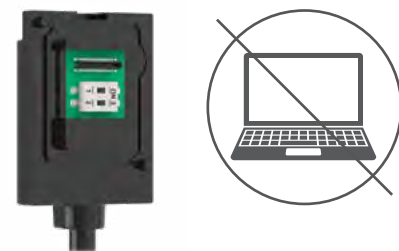

## 1. Select Emitter and Receiver

Series	Device Type	Resolution	Defined Area	Termination
<b>S4B</b>	<b>E</b>	<b>30</b>	<b>900</b>	<b>S</b>
	E = Emitter only R = Receiver only	14 = 14 mm 30 = 30 mm	300 = 300 mm 450 = 450 mm 600 = 600 mm 750 = 750 mm 900 = 900 mm 1050 = 1050 mm 1200 = 1200 mm 1350 = 1350 mm* 1500 = 1500 mm* 1650 = 1650 mm* 1800 = 1800 mm*	S = Single Emitter or Receiver (S4B Bracket(s) and S4B Cordset(s) sold separately)

\*Only available in 30 mm resolution

## 2. Add S4B Brackets (required)



S4BA-MBK-16

- Side mount bracket
- Rotation: +/- 15°
- Includes 2 brackets and hardware
- Each bracket supports 900 mm of length



S4BA-MBK-11

- End cap mounting bracket
- Rotation: +/- 15°
- Includes 2 brackets and adapters
- For lengths 1050 mm and longer

## 3. Add S4B Cordsets (required)



DES4-M51-D or DES4-M81-D

- S4B removable 5-pin or 8-pin male cable
- Includes one



S4BA-CASCADE-2, S4BA-CASCADE-3, or S4BA-CASCADE-4

- Cable kit for 2-4 S4B pairs
- 8-pin options available

Cascading Options

**Save Installation and Setup Time with Auto Cascading**

Auto cascading in the S4B speeds setup and installation, automatically recognizing the next light curtain as it is connected. The minimal response time impact when cascaded allows the S4B to be installed closer to the equipment being guarded, making more efficient use of valuable floor space.

**Simplify Installation and Maintenance with Specially Designed Cordsets**

Cordsets determine if the light curtain is used as a standalone pair or as part of a cascade. Specific connection genders and color-coded cordsets simplify and error-proof installation, using yellow for connecting multiple light curtain sticks while black runs back to the controller. Up to four pairs can be connected, including pairs of different resolutions or lengths.

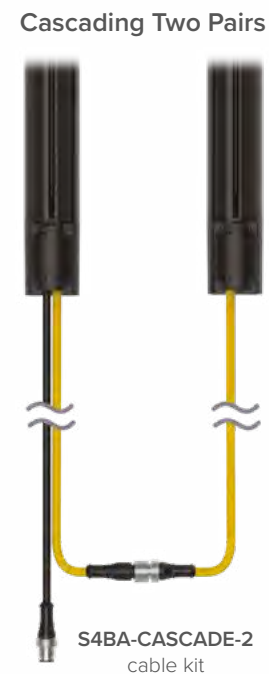
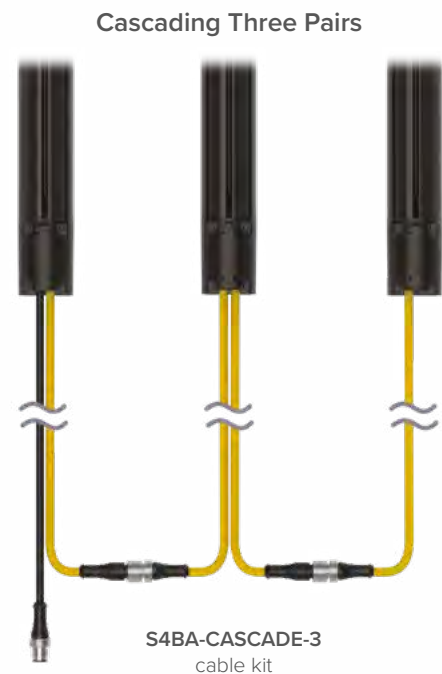

Muting Accessories

Muting allows objects to pass through operational light curtains by temporarily suspending their safety function, then resuming after the object has passed through the light curtain's beams. Mute arms protect sensors from damage and misalignment. Flexible mounting options for photoelectric sensors accommodate a wide range of object sizes passing through. The S4B muting junction box consolidates wiring by combining the S4B light curtains and non-safety sensors into one block.

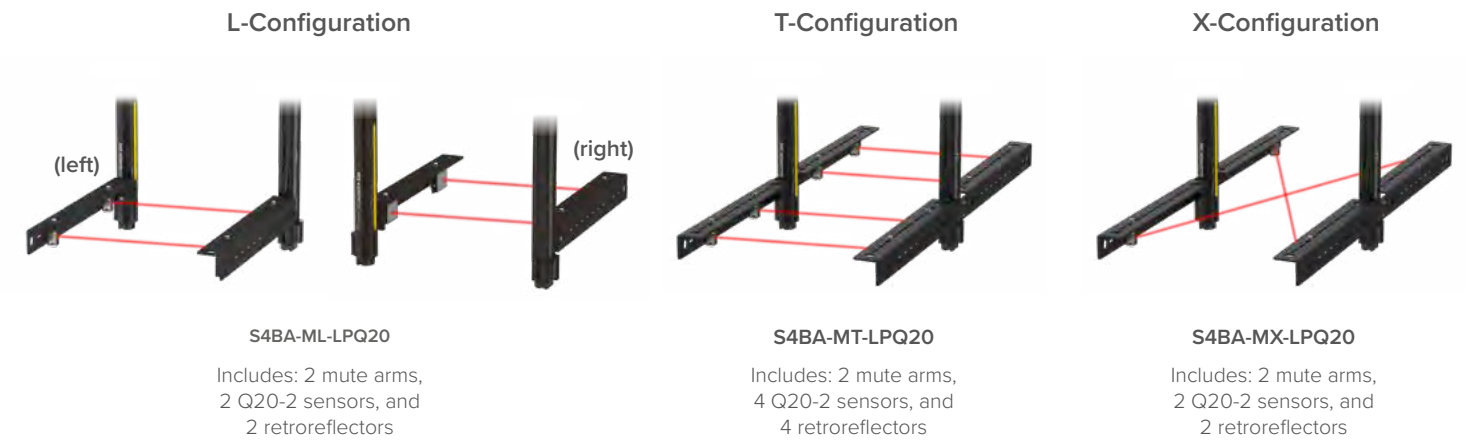

Mute Arm Kit	Box or Pallet Muting		
	Enter/Exit Direction	Width & Shape	Position on Conveyor
L-Configuration	One-way (exit)	Varying	Varying
X- Configuration	Bi-Directional	Consistent	Consistent
T-Configuration	Bi-Directional	Varying	Varying

Remote Fixed Blanking Accessories



With the turn of a key, Remote Fixed Blanking allows users to quickly configure portions of the S4B light curtain's sensing field to ignore fixed objects such as brackets, tooling, or part supports—enabling fast teaching or retooling to adapt to changes in fixture configuration or layout without accessing concealed DIP switches or cycling power. When changes have to happen, this keeps them short, simple, and controlled—so the line can recover fast. If a defined object is moved or removed, the system halts operation to maintain safety—and with another quick key turn, coverage is updated. Enable the built-in beam tolerance feature to prevent false trips caused by minor movement of fixed objects in high-vibration environments. When using the S4BA-RFB Remote Fixed Blanking Configuration Tool with a standalone emitter/ receiver pair, a cascade cable is required—even if no additional light curtain segments are connected.



# EZ-SCREEN LS Type 4 Heavy-Duty Light Curtains

The LS is a full-feature family of light curtains providing greater capabilities for cascading, blanking, EDM and more.

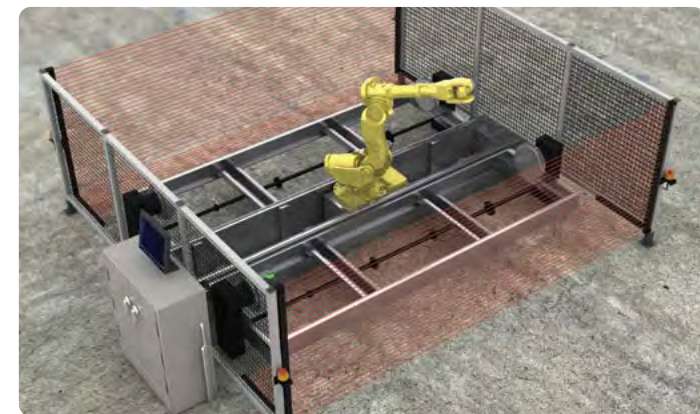
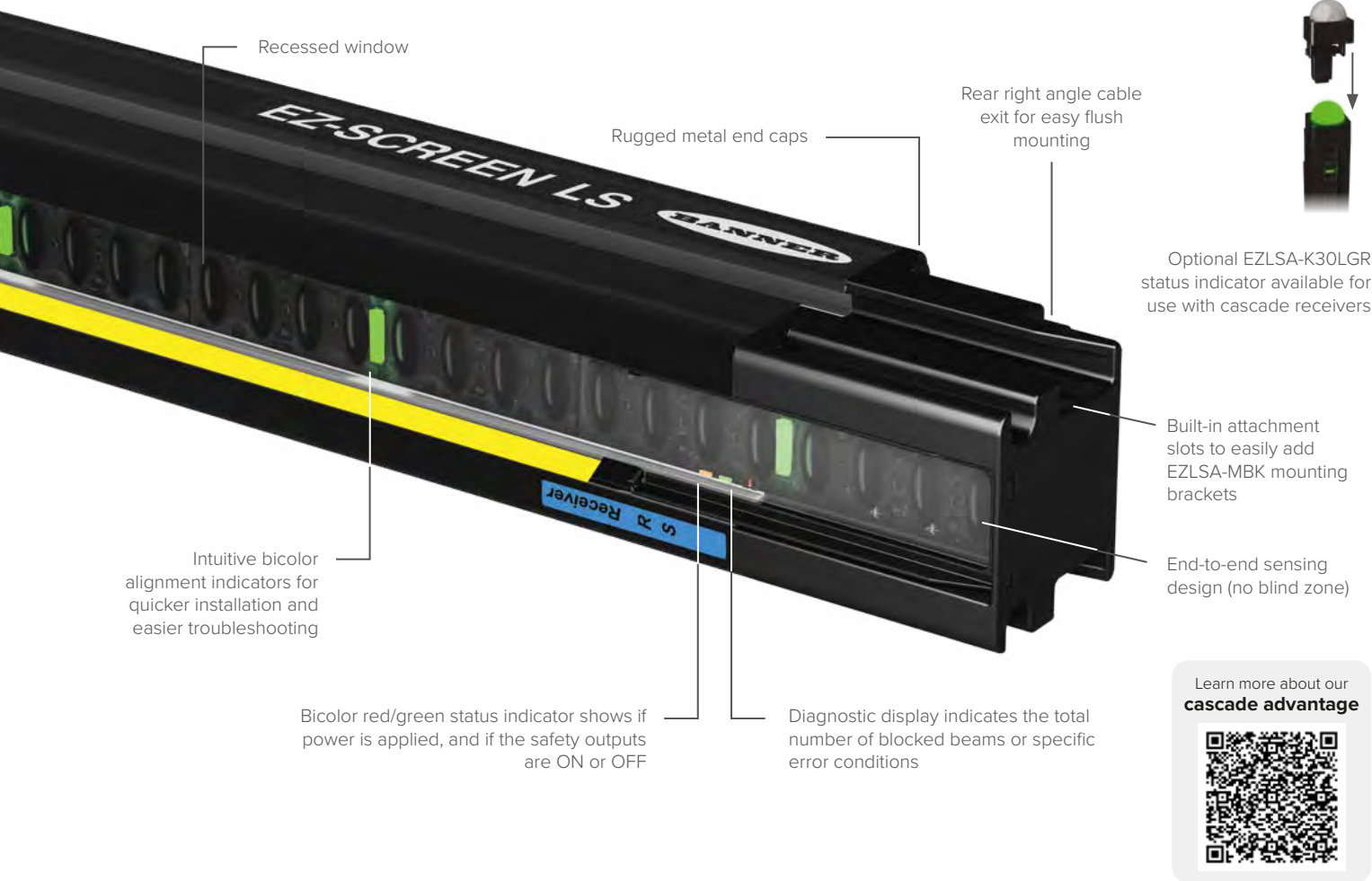

Due to its robust design, the EZ-SCREEN LS is the perfect fit in large robotic cell applications that require sturdy safety devices and heavy duty enclosures.



EZ-SCREEN LS light curtains in hygienic tubular enclosures successfully protect operators from injury and remain hygienic for easy cleaning procedures.

## 1. Select Emitter, Receiver, or Pair

Family	Cascade	System Type	Resolution	Defined Area	Termination	
<b>SLL</b>		<b>E</b>	<b>14</b>	<b>910</b>	<b>S</b>	
	Blank = Standard C = Cascade	E = Emitter only R = Receiver only P = Pair (Emitter and Receiver)	14 = 14 mm 23 = 23 mm 40 = 40 mm	280 = 280 mm* 350 = 350 mm 420 = 420 mm 490 = 490 mm 560 = 560 mm 630 = 630 mm 700 = 700 mm 770 = 770 mm 840 = 840 mm	910 = 910 mm 980 = 980 mm 1050 = 1050 mm 1120 = 1120 mm 1190 = 1190 mm 1260 = 1260 mm 1330 = 1330 mm 1400 = 1400 mm 1470 = 1470 mm	1540 = 1540 mm 1610 = 1610 mm 1680 = 1680 mm 1750 = 1750 mm 1820 = 1820 mm 1960L = 1960 mm** 2100L = 2100 mm** 2380L = 2380 mm**

\*Not available in cascade models  
\*\*23 mm resolution, IP65, 10 m range

S = emitter or receiver only (LS bracket(s) and LS cordset(s) ordered separately)  
P5 = Emitter or receiver includes one LS M12 double ended cordset (5-pin) and LS brackets (-11 and -12)  
P55 = Pair includes two LS M12 double ended cordsets (5-pin) and LS brackets (-11 and -12)  
P8 = Emitter or receiver includes one LS M12 double ended cordset (8-pin) and LS brackets (-11 and -12)  
P88 = Pair includes two LS M12 double ended cordsets (8-pin) and LS brackets (-11 and -12)  
Blank = Emitter, receiver or pair includes LS brackets (-11 and -12), LS cordset ordered separately

## 2. Add LS Brackets (for "-S" termination)



**EZLSA-MBK-11**

- End mount slotted steel bracket
- Rotation: 360° in 23° increments
- Includes two brackets
- Slotted mounting holes spaced 20 mm on-center



**EZLSA-MBK-12**

- Center mount steel bracket
- Rotation: +/- 15°
- Includes one bracket
- Use with EZLSA-MBK-11/-20 with a max of 980 mm unsupported



**EZLSA-MBK-16**

- Side mount die-cast bracket
- Rotation: +15° and -20°
- Includes one bracket
- Use one or multiple with a max of 980 mm unsupported



**EZLSA-MBK-20**

- End mount universal steel bracket
- Rotation: 360° in 23° increments
- Includes two brackets
- Universal mounting slots

## 3. Add LS Cordsets (for "-S" or "Blank" termination)



**LS-Custom to M12 Double Ended**

- DELSE-51D (5-Pin)**  
0.3 m (1')
- DELSE-81D (8-Pin)**  
0.3 m (1')



**Single Ended LS-Custom to Flying Leads**

- RDLS-515D (5-Pin)**  
4.6 m (15')
- RDLS-815D (8-Pin)**  
4.6 m (15')
- RDLS-825D (8-Pin)**  
8 m (26')
- RDLS-850D (8-Pin)**  
15.3 m (50')



**Double-Ended RD to RD Cordsets for Cascade Systems**

- DELS-111E**  
0.3 m (1')
- DELS-113E**  
1 m (3.3')
- DELS-1115E**  
4.6 m (15.1')

## IP69 Hygenic

Family	System Type	Resolution	Defined Area		Termination
<b>EZLSA-HTE</b>	<b>R</b>	<b>23</b>	<b>910</b>		
	E = Emitter R = Receiver	23 = 23 mm	280 = 280 mm* 350 = 350 mm 420 = 420 mm 490 = 490 mm 560 = 560 mm 630 = 630 mm	700 = 700 mm 770 = 770 mm 840 = 840 mm 910 = 910 mm 980 = 980 mm 1050 = 1050 mm	<b>Blank</b> = 7.6 m, 8-wire high durometer PVC cordset <b>F</b> = Remote Fixed Blanking Receiver model with additional 7.6 m cordset for blanking configuration
*Not available with remote fixed blanking option					



### Brackets



**EZLSA-MBK-HTE-1**

- Stamped stainless steel bracket
- 360° rotation for IP69 enclosure models
- Two brackets per optional kit



**EZLSA-MBK-HTE-2**

- Hygienic stainless steel bracket
- 360° rotation for IP69 enclosure models
- Two brackets per optional kit

### Mute Arm Kits

Create a turn-key muting solution for your EZ-SCREEN LS Safety Light Curtain

- With a 300 mm (1 ft) PVC cable with a 8-pin M12 male quick disconnect
- **Needs EZ-SCREEN LS Hardware Adaptor Kit EZLSA-MCB-HW**

#### L-Configuration

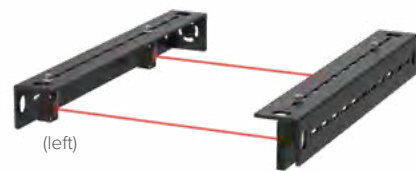

**SGSA-ML-L-LPQ20**

Includes 2 mute arms, 2 SGSA-Q20PLPQ5 mute sensors, and 2 retroreflectors

#### T-Configuration



**SGSA-MT-LPQ20**

Includes 4 mute arms, 4 SGSA-Q20PLPQ5 mute sensors, and 4 retroreflectors

#### X-Configuration



**SGSA-MX-LPQ20**

Includes 4 mute arms, 2 SGSA-Q20PLPQ5 mute sensors, and 2 retroreflectors

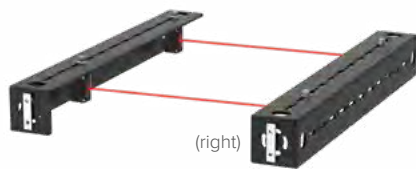

**SGSA-ML-R-LPQ20**

Includes 2 mute arms, 2 SGSA-Q20PLPQ5 mute sensors, and 2 retroreflectors

## Muting System Diagram

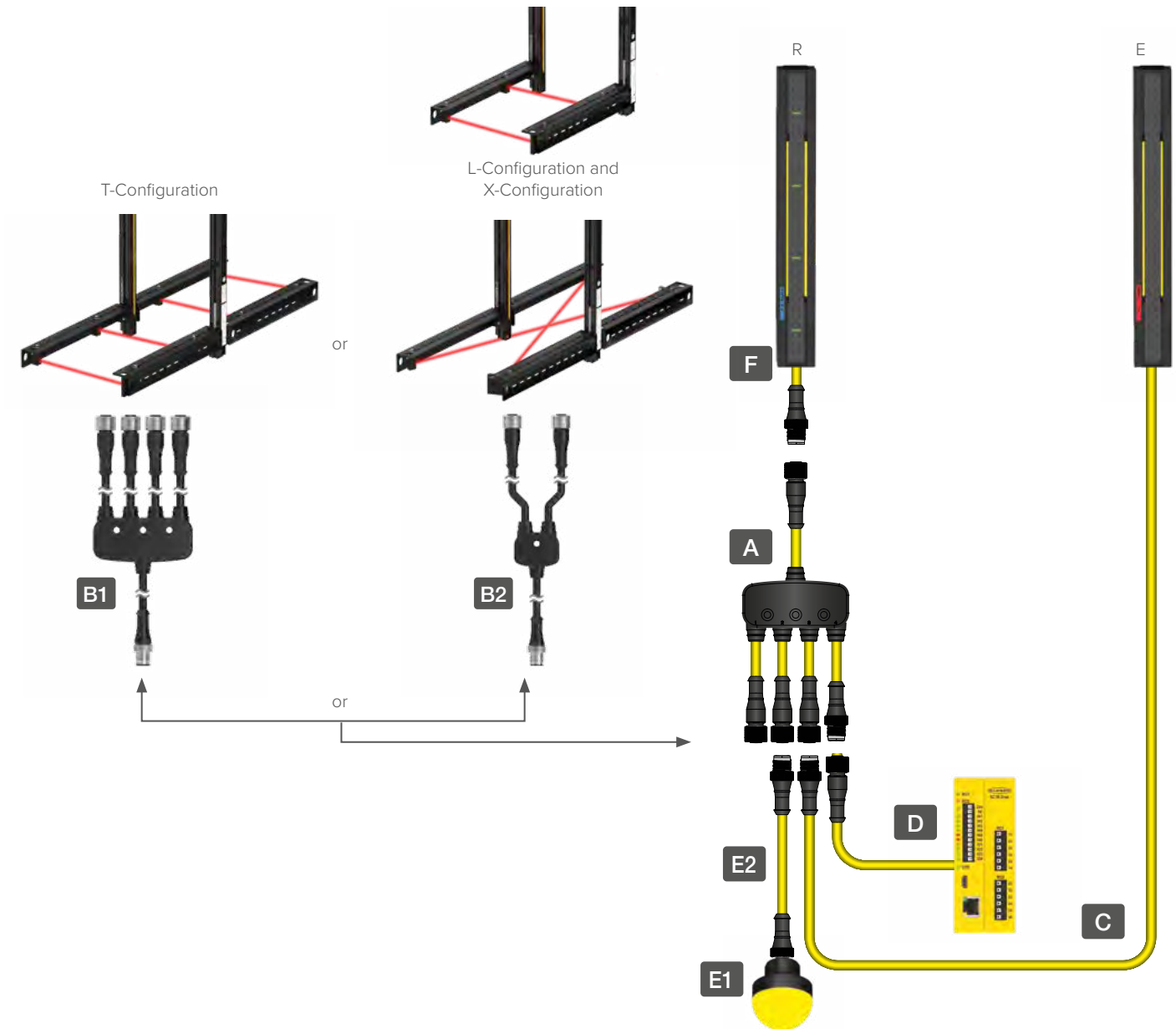

### Connection Cables

<b>A</b>	<b>CSM4-M1281M1251M1281</b> LS muting connection cable
<b>B</b>	SGS mute arm kit connection cable (select one) B1: T-Muting: <b>CSA4-M1251M1251M1251M1251</b> B2: L-Muting or X-Muting: <b>CSA-M1241M1241</b>
<b>C</b>	<b>DEE2R-8xxD</b> LS emitter connection cable (xx is the length in feet)
<b>D</b>	<b>QDEG-12xxE</b> Safety controller connection cable (xx is the length in feet)
<b>F</b>	<b>DELSE-81D (8-Pin)</b> LS receiver connection cable (M12)

### Mute Lights and Cables

<b>E1</b>	<b>TL50WQ, TL50YQ, K50LWXXPQ, K50LYXXPQ</b> Mute lights (xx is the length in feet)
<b>E2</b>	<b>DEE2R-5xx</b> Mute light cable (xx is the length in feet)

### Interface options

Interface Modules (see page 46)

# EZ-SCREEN 14/30 Type 4 Light Curtains

Banner's traditional light curtain, the EZ-Screen 14/30 provides the longest sensing range, reduced resolution, and includes trip or latch/reset functionality.



Offers optional cascading to create a system that responds to a single stop command

Learn more about our **cascade advantage**



## 1. Select Emitter and Receiver

Family	Cascade	System Type	Resolution	Defined Area		Finish	Termination
<b>SLS</b>	<b>C</b>	<b>P</b>	<b>14</b>	<b>150</b>			<b>Q88</b>
	<b>C</b> = Cascade <b>Blank</b> = No cascading	<b>E</b> = Emitter <b>R</b> = Receiver <b>P</b> = Pair	<b>14</b> = 14 mm <b>30</b> = 30 mm	<b>150</b> = 150 mm* <b>300</b> = 300 mm <b>450</b> = 450 mm <b>600</b> = 600 mm <b>750</b> = 750 mm <b>900</b> = 900 mm <b>1050</b> = 1050 mm <b>1200</b> = 1200 mm	<b>1350</b> = 1350 mm <b>1500</b> = 1500 mm <b>1650</b> = 1650 mm <b>1800</b> = 1800 mm <b>1950</b> = 1950 mm** <b>2100</b> = 2100 mm** <b>2250</b> = 2250 mm** <b>2400</b> = 2400 mm**		
<small>*Not available in cascade models **Only available in 30 mm resolution</small>							
<b>Blank</b> = Yellow powder coat <b>N</b> = Nickel-plated ESD <small>(ESD-safe models are not available with pigtail QD)</small> <b>A</b> = Clear anodized aluminium							
<b>Q8</b> = 8-pin M12 QD (individual Emitter or Receiver models) <b>P8</b> = 8-pin M12 pigtail QD (individual Emitter or Receiver models) <b>Q88</b> = For Pair – Emitter with 8-pin M12 QD, Receiver with 8-pin QD <b>P88</b> = For Pair – Emitter with 8-pin M12 pigtail QD, Receiver with 8-pin M12 pigtail QD							

## 2. Add Brackets



**EZA-MBK-11**

- Standard mounting L-bracket



**EZA-MBK-12**

- Center mounting bracket



**EZA-MBK-20**

- Retrofit bracket for mounting to engineered/slotted aluminum framing



**EZA-MBK-21**

- Mounting bracket system for L configuration of two cascaded light screens
- One EZA-MBK-21 kit contains brackets for one side of an L-mounting configuration

# EZ-SCREEN LP Type 4 Compact Light Curtains

Banner's compact full-feature family of light curtains providing capabilities for cascading, blanking, integral muting, latch/reset, EDM, and more.

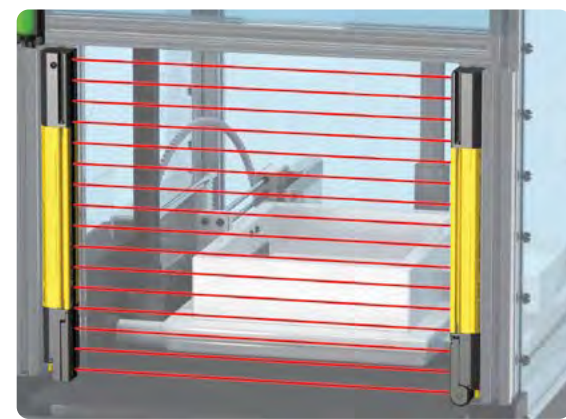
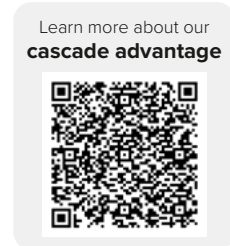
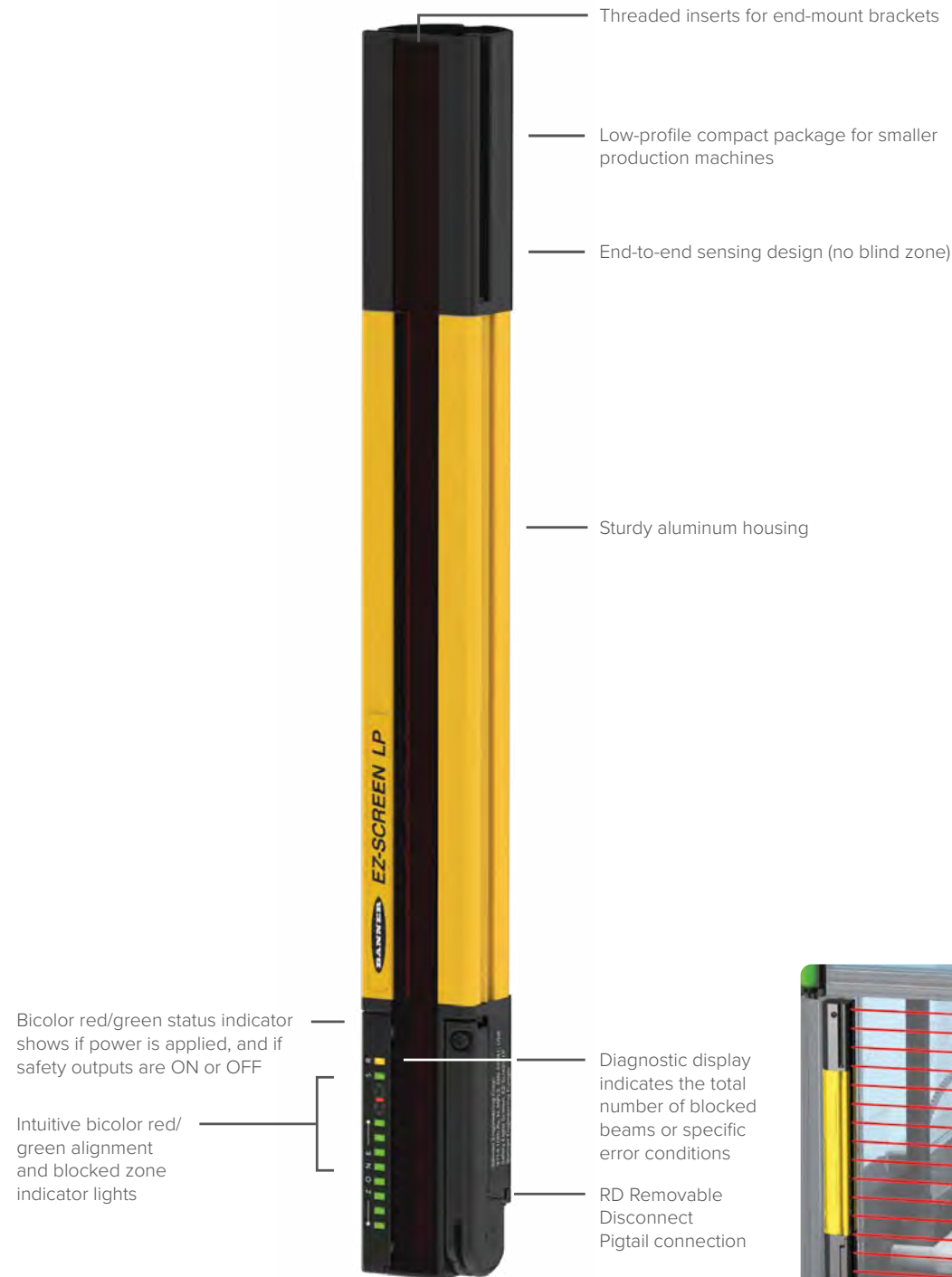

The EZ-SCREEN LP safety light screen is compact and mounts in tight spaces with its continual end-to-end sensing that leaves no gaps.

## 1. Select Emitter and Receiver

### EZ Screen LP

Family	Cascade	System Type	Resolution	Defined Area	Termination
<b>SLP</b>	<b>C</b>	<b>P</b>	<b>14</b>	— <b>410</b>	<b>P88</b>
	<b>C</b> = Cascade* <b>Blank</b> = Standard <b>VA</b> = LP Basic	<b>P</b> = Pair (Emitter and Receiver) <b>E</b> = Emitter only <b>R</b> = Receiver only	<b>14</b> = 14 mm <b>25</b> = 25 mm	<b>270</b> = 270 mm** <b>410</b> = 410 mm <b>550</b> = 550 mm <b>690</b> = 690 mm	<b>830</b> = 830 mm† <b>970</b> = 970 mm† <b>1110</b> = 1110 mm† <b>1250</b> = 1250 mm†
<p>Note: LP Basic contains individual emitter and/or receiver only. Brackets and cordset ordered separately</p> <p><b>P8</b> = 300 mm 8-Pin M12 pigtail QD (individual Emitter or Receiver models)  <b>P88</b> = 300 mm 8-Pin M12 pigtail QD (on BOTH Emitter and Receiver models)  <b>Blank</b> = no pigtail, RD connection (for RDLP-8..D cordset)</p> <p>*8-pin connection required for cascade models and to enable EDM, Aux Output and Reset features                  **Not available in cascade models                  †Not available in LP Basic models</p>					

### EZ Screen LP with Muting

Family	Resolution	Defined Area	Finish	Termination	
<b>SLPMP</b>	<b>14</b>	— <b>410</b>			
<b>SLPE</b> = Emitter <b>SLPMR</b> = Receiver <b>SLPMP</b> = Pair	<b>14</b> = 14 mm <b>25</b> = 25 mm	<b>410</b> = 410 mm <b>550</b> = 550 mm <b>690</b> = 690 mm <b>830</b> = 830 mm	<b>970</b> = 970 mm <b>1110</b> = 1110 mm <b>1250</b> = 1250 mm	<b>Blank</b> = Yellow powder coat <b>N</b> = Nickel-plated ESD <b>A</b> = Clear anodized aluminium	<b>Blank</b> = Integral Removable Disconnect <b>P8</b> = 8-pin pigtail QD (SLPE) <b>P12</b> = 12-pin pigtail QD (SLPMR) <b>P128</b> = For SLPMP (Pair) Emitter with 8-pin M12 pigtail QD Receiver with 12-pin M12 pigtail QD

## 2. Add Brackets

LPA-MBK-10	LPA-MBK-11	LPA-MBK-12	LPA-MBK-16	LPA-MBK-21	LP-Custom to M12 Male QD
<ul style="list-style-type: none"> <li>End mount bracket</li> <li>Rotation: 40°</li> <li>Includes 2 brackets and hardware</li> <li>14 ga. steel, black zinc-plated</li> </ul>	<ul style="list-style-type: none"> <li>Standard end mount bracket</li> <li>Rotation: 360°</li> <li>Includes 2 brackets and hardware</li> <li>14 ga. steel, black zinc-plated</li> </ul>	<ul style="list-style-type: none"> <li>Standard side mount bracket</li> <li>Rotation: +10° and -30°</li> <li>Includes 1 bracket and hardware</li> <li>14 ga. steel, black zinc-plated</li> </ul>	<ul style="list-style-type: none"> <li>Side mount bracket</li> <li>Rotation: +15° and -20°</li> <li>Includes 1 bracket and hardware</li> <li>Black zinc die-cast</li> </ul>	<ul style="list-style-type: none"> <li>Pivoting cascade mounting bracket</li> <li>Includes 2 brackets and hardware</li> <li>14 ga. steel, black zinc-plated</li> </ul>	<ul style="list-style-type: none"> <li>DELPE-51D (5-pin) 0.3 m (1 ft)</li> <li>DELPE-81D (8-pin) 0.3 m (1 ft)</li> </ul>

## 3. Add Cordsets

# EZ-SCREEN LS2 Type 2 Light Curtains

Designed for lower-risk applications such as bump or bruise, knock-down, trapping but not crushing, or minor cuts and abrasions.

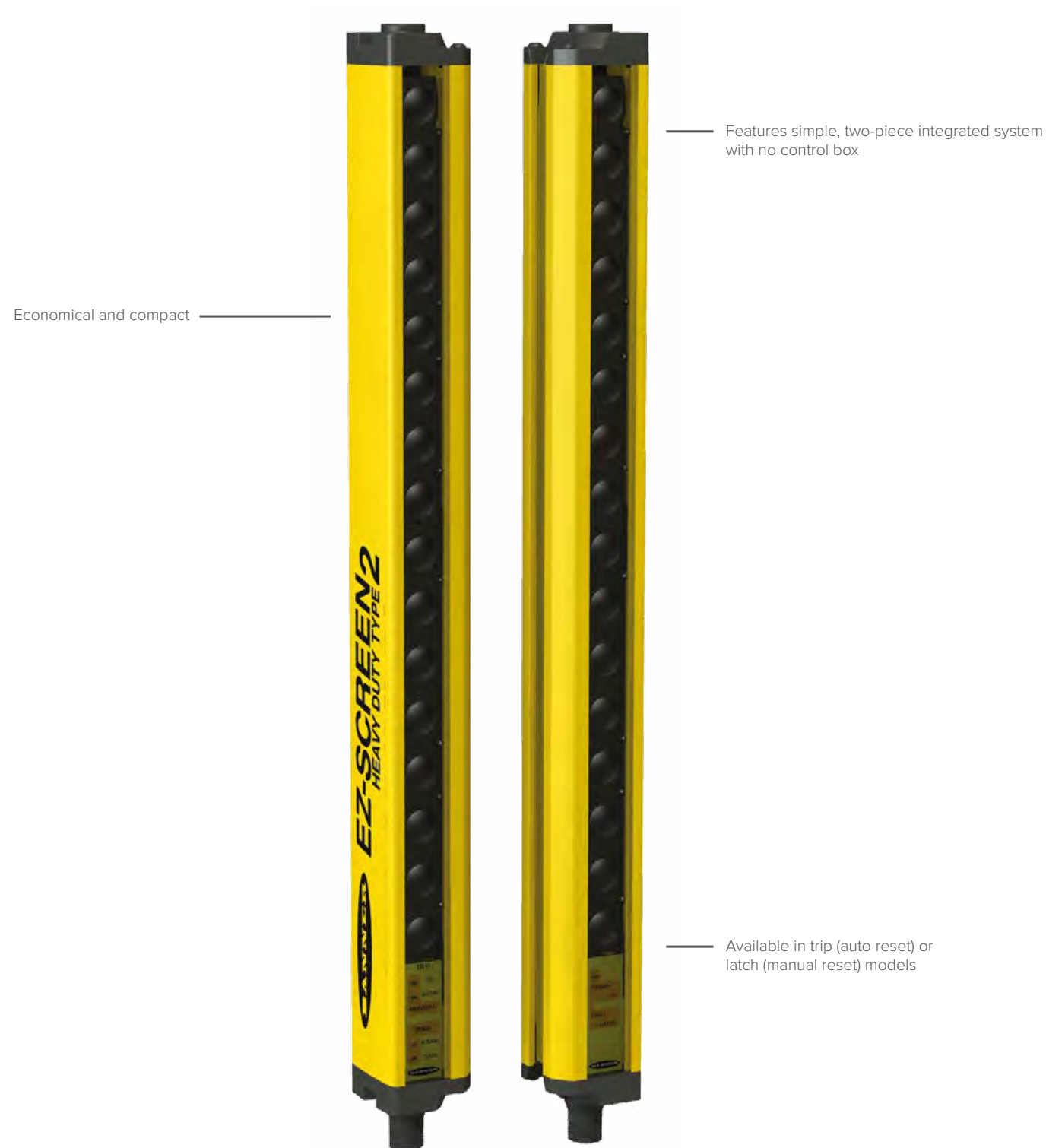

## 1. Select Emitter and Receiver

Family	System Type	Resolution	Defined Area		Termination
<b>LS2</b>	<b>TP</b>	<b>30</b>	<b>150</b>		<b>Q88</b>
	E = Emitter TR = Trip Receiver TP = Trip Pair LR = Latch Receiver LP = Latch Pair	30 = 30 mm	150 = 150 mm 300 = 300 mm 450 = 450 mm 600 = 600 mm 750 = 750 mm 900 = 900 mm	1050 = 1050 mm 1200 = 1200 mm 1350 = 1350 mm 1500 = 1500 mm 1650 = 1650 mm 1800 = 1800 mm	Q8 = 8-pin QD (individual Emitter or Receiver models) Q88 = For pair: Emitter with 8-pin M12 QD, Receiver with 8-pin M12 QD

## 2. Add Brackets



**USMB-5**

- Retrofit mounting bracket
- 2.3 mm thickness, black zinc-plated, chromate dip finish
- Mounting hardware included: 1 kit required per emitter or receiver



**USMB-6**

- Universal mounting bracket kit
- 2.3 mm thickness, black zinc-plated, chromate dip finish
- Mounting hardware included: 1 kit required per emitter or receiver



**USMB-8**

- Low profile mounting plate for 90° sensor direction
- Black anodized aluminum
- Uses two M4 screws (user supplied) for through-hole mounting
- 1 kit required per emitter or receiver



**8-Pin M12 with Flying Leads**

- QDE-815D 4.5 m (15')
- QDE-825D 7.6 m (25')
- QDE-850D 15.2 m (50')



The Type 2 EZ-SCREEN safety light screen protects hands and fingers from being bumped, bruised, or pinched by the moving parts of a carousel.

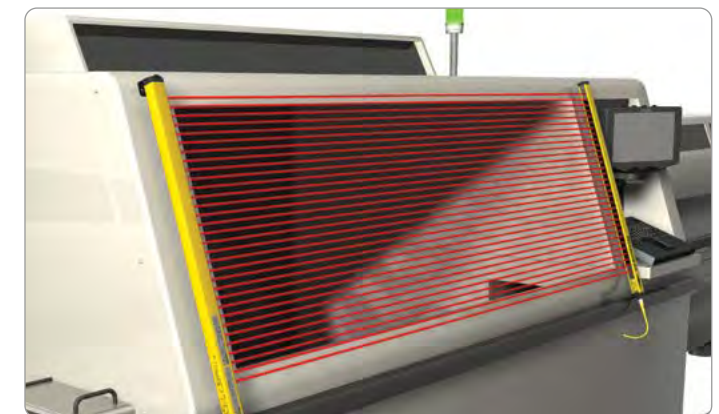

The Type 2 EZ-SCREEN safety light screen guards the opening to a chip shooter, which has moving parts that can cause painful but usually temporary injuries.

# SGS Type 4 Safety Light Grids

Two to four beam Type 4 safety light grids protect personnel from injury and machines from damage by guarding access, areas, and perimeters. Able to detect a body in a cost-effective and heavy-duty safety light curtain package.

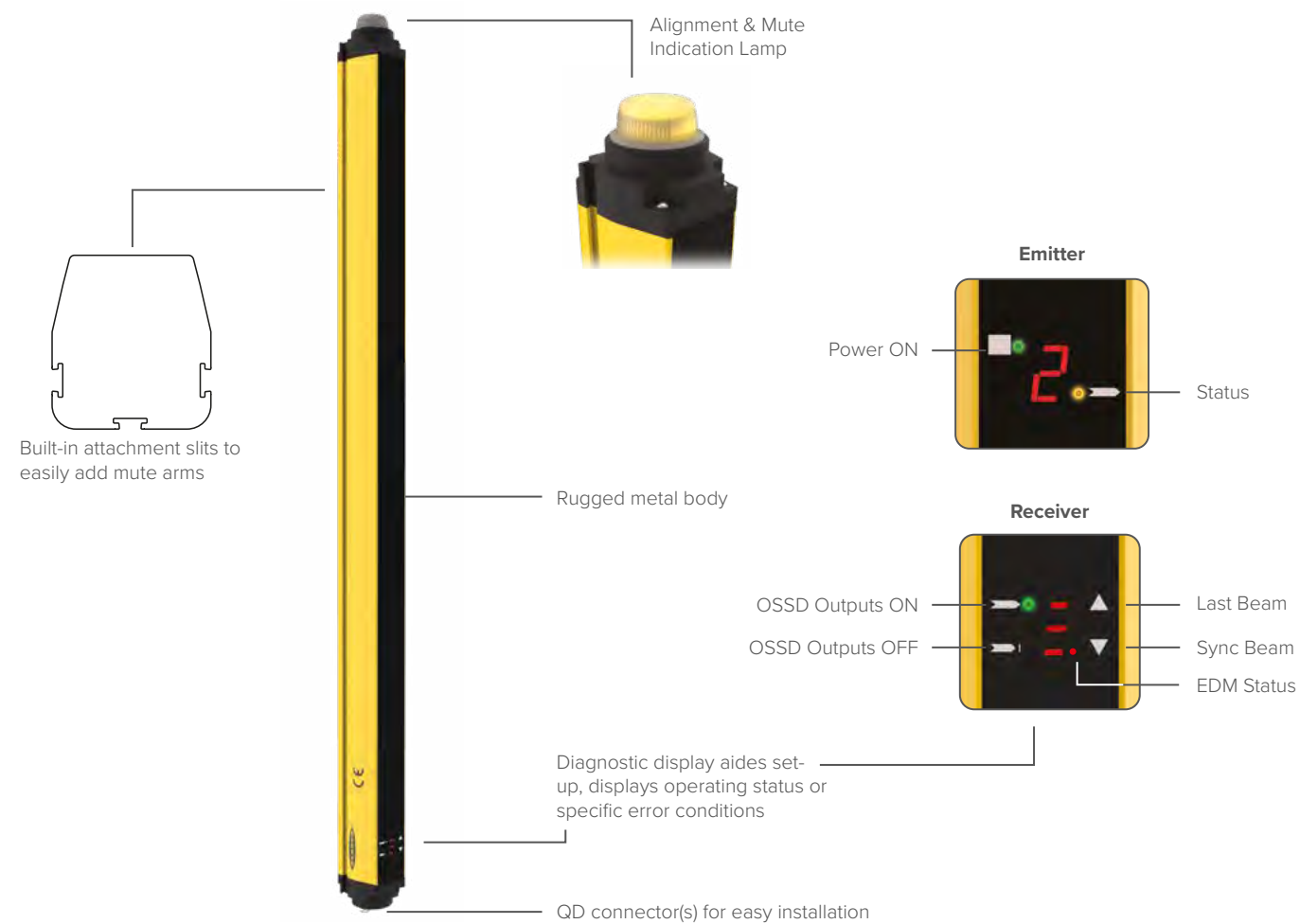

SGS Safety Grid Systems, with two, three, or four beams, are used to monitor the perimeter of the work area.

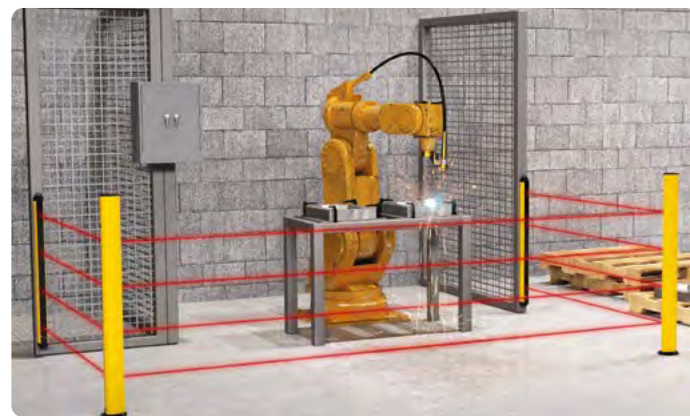

SGS Safety Grid Systems are available in Emitter/Receiver models capable of safeguarding over very long distances and in easy-to-deploy Active/Passive models.

## SGS Emitter/Receiver

- When compared to higher resolution light screens, a lower cost option for body detection applications
- Available with integral muting
- Long range, up to 60 m

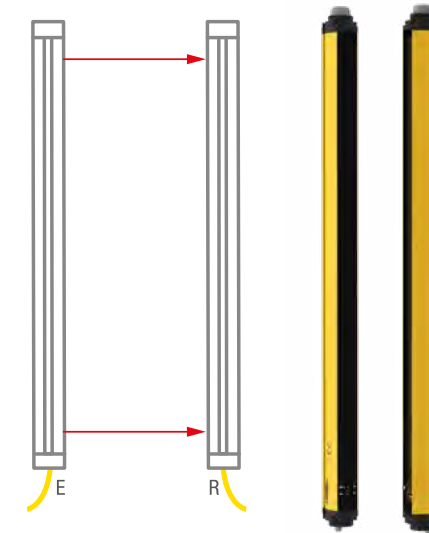

Type	Range (m)	Integral Muting	Protective Height (mm)	Models
Emitter & Receiver	6 to 60	No	500 (2 beams)	<b>SGSXP2-500Q88</b>
			800 (3 beams)	<b>SGSXP3-400Q88</b>
			900 (4 beams)	<b>SGSXP4-300Q88</b>
			1200 (4 beams)	<b>SGSXP4-400Q88</b>
	0.5 to 30	No	500 (2 beams)	<b>SGSSP2-500Q88</b>
			800 (3 beams)	<b>SGSSP3-400Q88</b>
			900 (4 beams)	<b>SGSSP4-300Q88</b>
			1200 (4 beams)	<b>SGSSP4-400Q88</b>
	0.5 to 30	Yes	500 (2 beams)	<b>SGSMP2-500Q128</b>
			800 (3 beams)	<b>SGSMP3-400Q128</b>
			900 (4 beams)	<b>SGSMP4-300Q128</b>
			1200 (4 beams)	<b>SGSMP4-400Q128</b>

## SGS Active/Passive

- Active transceiver contains emitter and receiver
- Reduces overall wiring costs
- Available with integral muting
- Up to 8 m range

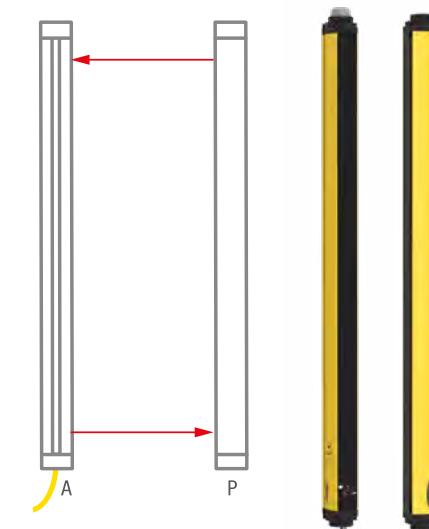

Type	Range (m)	Integral Muting	Protective Height (mm)	Models
Active Transceiver	0.5 to 8	No	500 (2 beams)	<b>SGSSA2-500Q8</b>
			800 (3 beams)	<b>SGSSA3-400Q8</b>
			900 (4 beams)	<b>SGSSA4-300Q8</b>
	0.5 to 8	Yes	500 (2 beams)	<b>SGSMA2-500Q12</b>
			800 (3 beams)	<b>SGSMA3-400Q12</b>
			900 (4 beams)	<b>SGSMA4-300Q12</b>
			1200 (4 beams)	<b>SGSMA4-400Q12</b>

### Passive Mirror

Type	Range (m)	Protective Height (mm)	Models
Passive Mirror Assembly	Pair with Active Transceivers with matching beams and protective heights	500 (2 beams)	<b>SGSB2-500</b>
		800 (3 beams)	<b>SGSB3-400</b>
		900 (4 beams)	<b>SGSB4-300</b>
		1200 (4 beams)	<b>SGSB4-400</b>

## Mute Arm Kits

Preassembled (with mounting hardware) for plug-and-play connection to the SGS grid and LS Safety Light Curtains

- Wiring connection block or cable accessories available
- Adjusts easily for line changes
- Hardware kit to attach mute arms to LS curtains, EZLSA-MCB-HW, ordered separately from mute arm kits

### L-Configuration

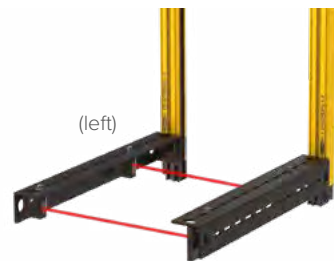

**SGSA-ML-L-LPQ20**

Includes 2 mute arms, 2 SGSA-Q20PLPQ5 mute sensors, and 2 retroreflectors

### T-Configuration



**SGSA-MT-LPQ20**

Includes 4 mute arms, 4 SGSA-Q20PLPQ5 mute sensors, and 4 retroreflectors

### X-Configuration

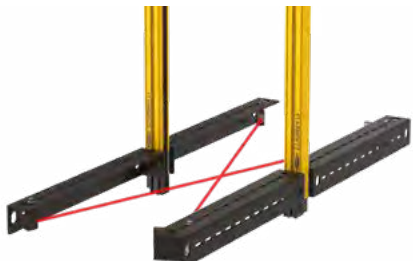

**SGSA-MX-LPQ20**

Includes 4 mute arms, 2 SGSA-Q20PLPQ5 mute sensors, and 2 retroreflectors

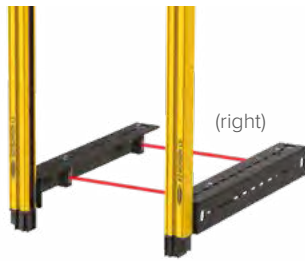

**SGSA-ML-R-LPQ20**

Includes 2 mute arms, 2 SGSA-Q20PLPQ5 mute sensors, and 2 retroreflectors



Integral muting models have muting technology built into the device eliminating the need for an external muting controller. Preassembled muting arm kits are available in T, L and X configurations. The muting kits use premounted hardware and Q20 retroreflective sensors and reflectors.

### Benefits of Muting

- Maintain high safety standards while allowing for a predetermined object to break a beam
- Limit downtime by not unnecessarily shutting down a conveyor or robot cell

### Applications

- Assembly and packaging machines
- Automated production equipment
- Robotic work cells
- Automated warehouses
- Palletizers

## Mute Connection Options

Description	Models
Connection box for X, L or T mute arm kits	<b>SGSA-MCB</b>
Connection cable for X and L mute arm kits	<b>SGSA-MCS-2</b>
Connection cable for T mute arm kits	<b>SGSA-MCS-4</b>
Optional hardware kit for mounting mute connection box, or mute connection cable to the t-slot of SGS Receiver or Active Unit	<b>SGSA-MCB-HW</b>

## Stands and Corner Mirrors



### SGSA-S Series Enclosures

Fits SGS Models	# of Windows	Enclosure Height	Distance from Floor to Bottom Window	Distance between Beams	Enclosure Models
SGS..4-300Q..	4	1543 mm (60.75")	300 mm (11.8")	300 mm (11.8")	<b>SGSA4-S300</b> <b>SGSA4-S300-M</b>
SGS..3-400Q..	3	1238 mm (48.78")	300 mm (11.8")	400 mm (15.8")	<b>SGSA3-S400</b> <b>SGSA3-S400-M</b>
SGS..4-400Q..	4	1618 mm (63.69")	300 mm (11.8")	400 mm (15.8")	<b>SGSA4-S400</b> <b>SGSA4-S400-M</b>
SGS..2-500Q..	2	1035 mm (40.75")	400 mm (15.8")	500 mm (19.7")	<b>SGSA2-S500</b> <b>SGSA2-S500-M</b>



### SSM Series Corner Mirrors

Fits SGS Models	Reflective Area	Mounting Area	Mirror Height	Mirror Models
SGS..2-500..	550 mm (21.7")	661 mm (26.0")	628 mm (24.7")	<b>SSM-550</b>
SGS..3-400..	825 mm (32.5")	936 mm (36.9")	903 mm (35.6")	<b>SSM-825</b>
SGS..4-300..	975 mm (38.4")	1086 mm (42.8")	1053 mm (41.5")	<b>SSM-975</b>
SGS..4-400..	1275 mm (50.2")	1386 mm (54.6")	1353 mm (53.3")	<b>SSM-1275</b>



### MSA Series Stands

Pole Height	Usable Stand Height	Stand Models
1676 mm (66")	1550 mm (61")	<b>MSA-S66-1</b>
2134 mm (84")	2007 mm (79")	<b>MSA-A84-1</b>
2667 mm (105")	2667 mm (100")	<b>MSA-S105-1</b>

## Cables



### 8-Pin M12 with Flying Leads

**QDE-815D**  
4.5 m (15')  
**QDE-825D**  
7.6 m (25')  
**QDE-850D**  
15.2 m (50')



### 12-Pin M12 with Flying Leads

**QDE-1215E**  
4.5 m (15')  
**QDE-1225E**  
7.6 m (25')  
**QDE-1250E**  
15.2 m (50')

## Brackets



**SA-MBK-10-4**  
End-mount bracket

# Safety Scanner Selection Guide



**SX5-B6**



**SX5-M10**



**SX5-M70**



**SX5-ME70**



**SX5-R**

	p. 32	p. 32
<b>Dimensions W x D x H (mm)</b>	102 x 112 x 152	102 x 112 x 152
<b>Presence Detection</b>	50/70 mm	50/70 mm
<b>Body Detection</b>	70/150 mm	70/150 mm
<b>Hand Detection</b>	30/40 mm	30/40 mm
<b>Range</b> (depending on resolution)	30 mm = 2.5 m 40 mm = 3 m 50 mm = 4 m 70/150 mm = 5.5 m	30 mm = 2.5 m 40 mm = 3 m 50 mm = 4 m 70/150 mm = 5.5 m
<b>Max. Zone Sets</b> (depending on configuration)	6	10
<b>Master Remote</b>		Master (up to 3 remotes)
<b>Removable Memory</b>		SXA-RM-10
<b>Speed Monitoring</b>		
<b>Max. OSSD Outputs</b> (depending on configuration)	1x 2 OSSD	2x 2 OSSD
<b>Inter Device Connection</b>		8-Pin M12
<b>Integral Muting</b>	✓	✓
<b>Programmable Dust Filter</b>	✓	✓
<b>Measurement Data</b>	✓	✓
<b>Field-replaceable Window</b>	✓	✓
<b>Muting/bypass</b>		

p. 32	p. 32	p. 32
102 x 112 x 152	102 x 112 x 152	102 x 112 x 152
50/70 mm	50/70 mm	50/70 mm
70/150 mm	70/150 mm	70/150 mm
30/40 mm	30/40 mm	30/40 mm
30 mm = 2.5 m 40 mm = 3 m 50 mm = 4 m 70/150 mm = 5.5 m	30 mm = 2.5 m 40 mm = 3 m 50 mm = 4 m 70/150 mm = 5.5 m	30 mm = 2.5 m 40 mm = 3 m 50 mm = 4 m 70/150 mm = 5.5 m
70	70	depending on master
Master (up to 3 remotes)	Master (up to 3 remotes)	Remote
SXA-RM-70	SXA-RM-70	
	✓	
3x 2 OSSD	3x 2 OSSD	
8-Pin M12	8-Pin M12	8-Pin M12
✓	✓	✓
✓	✓	✓
✓	✓	✓
✓	✓	✓
✓	✓	

# Safety Scanner System

Horizontal or vertical monitoring of both personnel and stationary or mobile systems

SX Series safety laser scanners protect personnel, equipment, and mobile systems by continuously scanning a user-defined area of up to 275° to create a two-dimensional protected zone.

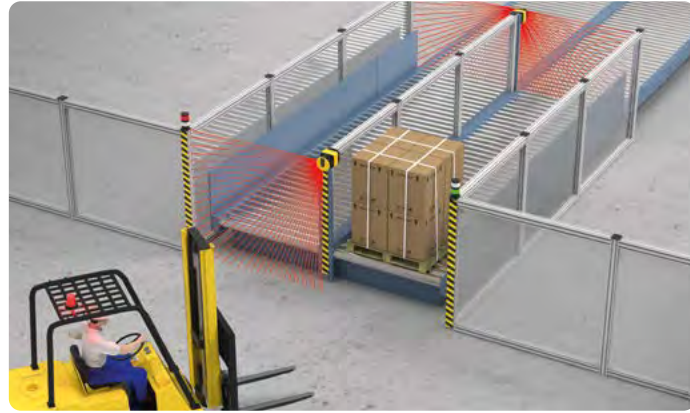

SX5 software configuration allows zone switching for full, right-side and left-side safety protection during this forklift access application.



Software interface makes it easy to create custom safety and warning zones to safeguard large, complex, and irregularly shaped areas.

Increased Machine Uptime

The SX5 has on-board LED indicators and a large multi-segment color display that provide at-a-glance system status information so users can quickly identify zone breaches and resolve issues with a minimal amount of equipment downtime.

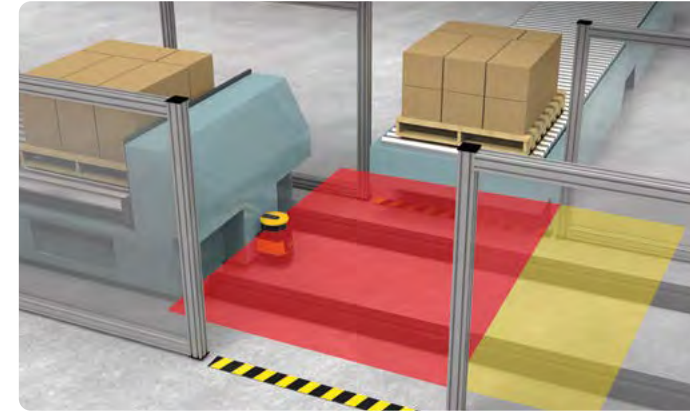

Compact, one-piece safety device installs easily above and away from area hazards without requiring time-consuming alterations to area infrastructure.

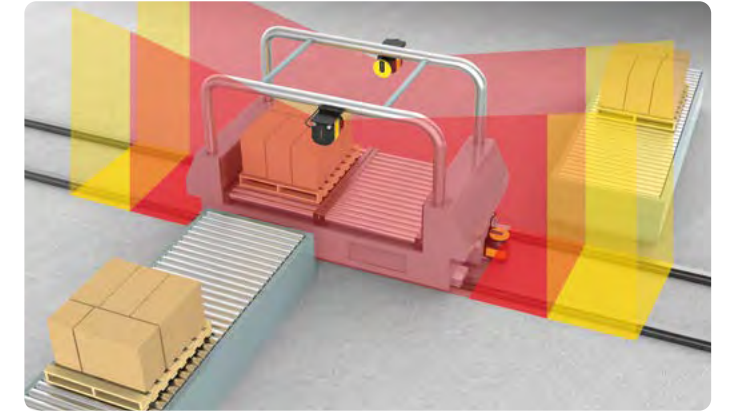

An alert is triggered if an object enters the warning zone and equipment will come to a stop if the safety zone is breached.

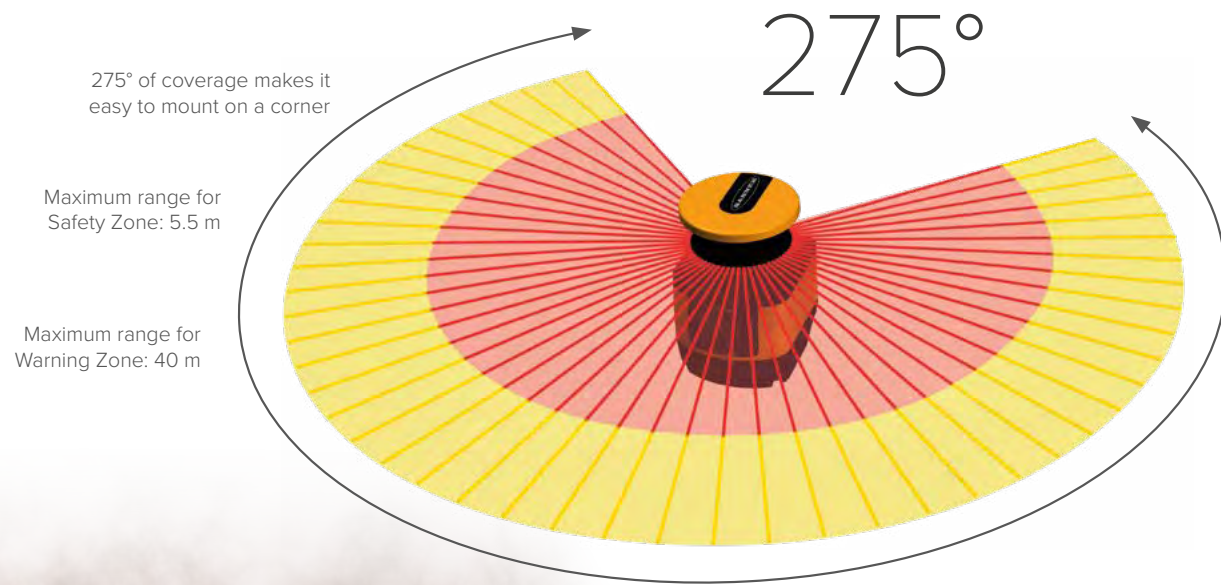

Light Immune and dust resistant – Best in class

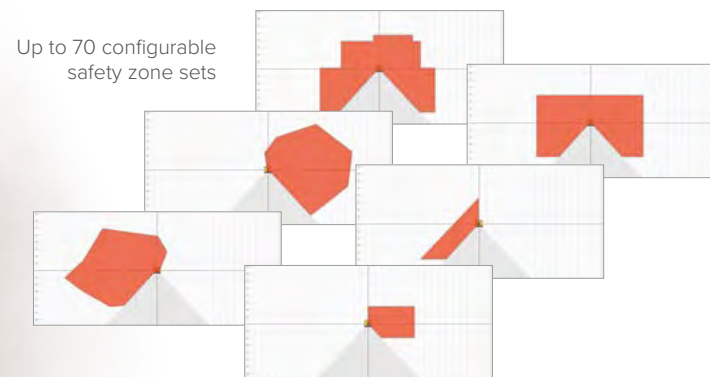

Up to 70 configurable safety zone sets



Rugged design for reliable industrial use

Numerous status, diagnostic, warning, and error displays

Dynamic Muting available and selectable detection capability for vertical applications



- LED 1: Object Detection in Safety Zone (OSSD)
- LED 2: Not Available
- LED 3: Assigned to Warning Zone 2
- LED 4: Assigned to Warning Zone 1
- LED 5: Interlock Status (waiting for Reset)



Keypad

M12 Ethernet connector cover for standalone models

# Safety Scanner System

## Removable memory for fast scanner replacement

The system configuration is backed up in a removable memory unit. Install your replacement scanner fast and easy, without needing to reconfigure your system. The machine interface cables attach to this memory unit on the Master models.



## Master and Remote connection reduces wiring

For applications that require monitoring multiple sides of an AGV, up to four scanners can be easily connected through an Ethernet-based safe communications bus, working as a single system.

Each remote unit is connected to the master by a single cable that provides them with power, and the memory of the entire system is stored in the master.

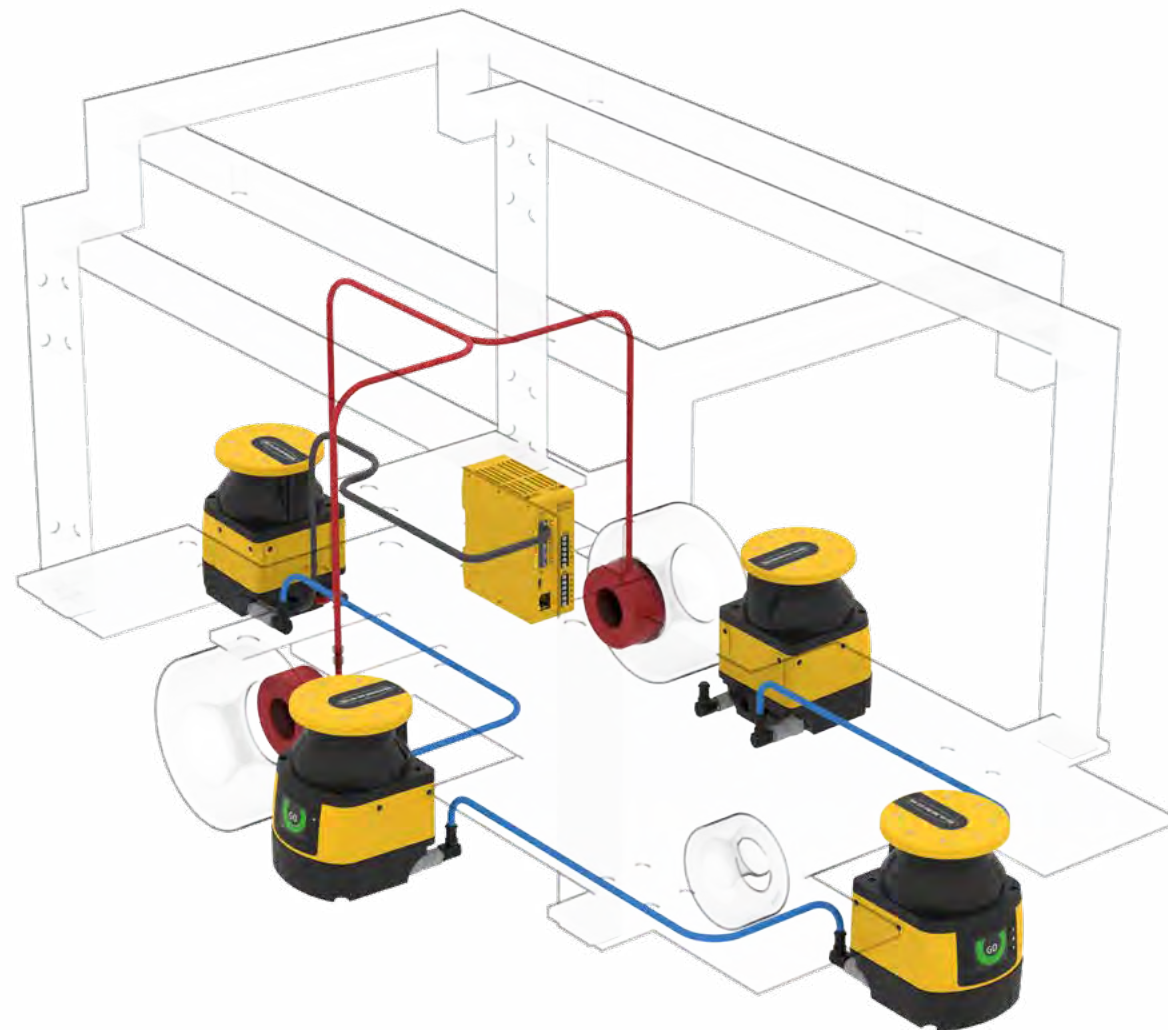
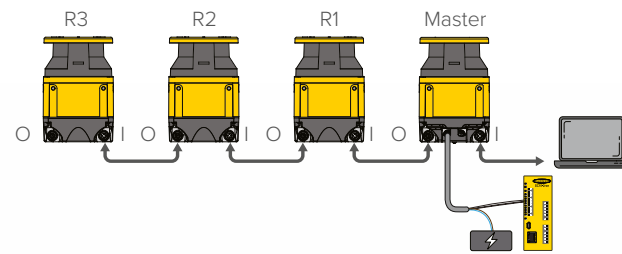

# Safety Scanner Software

## Simple setup for rapid deployment

The SX5 can be set up in just a few simple steps using Banner's free configuration software. This robust software features menu-driven tools that guide users through setup and make it easy to design custom safety and warning zones to accommodate existing infrastructure and meet the specific needs of any application.

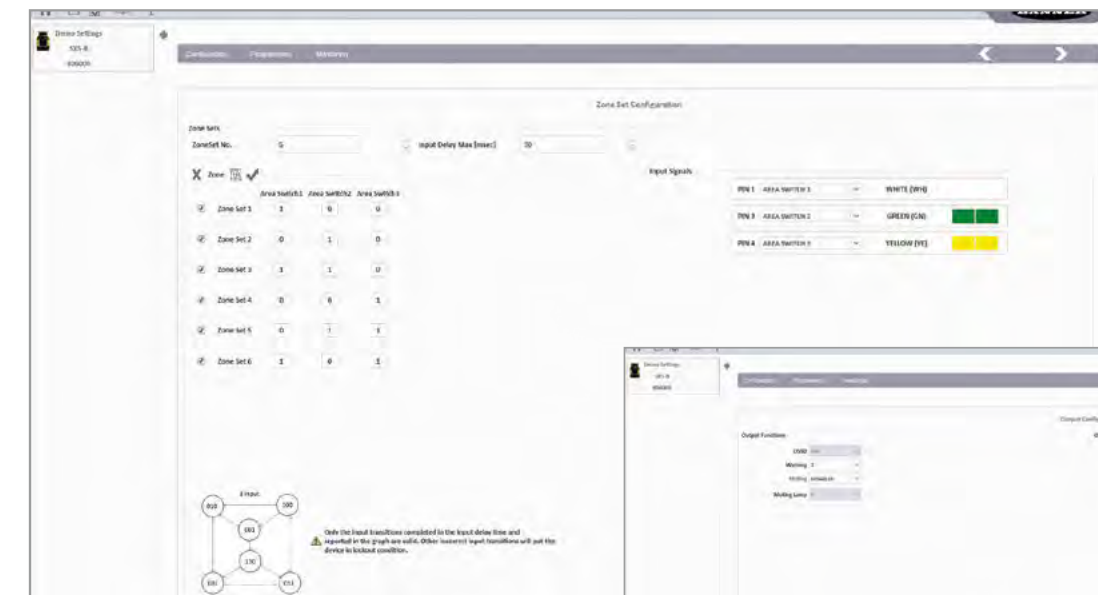
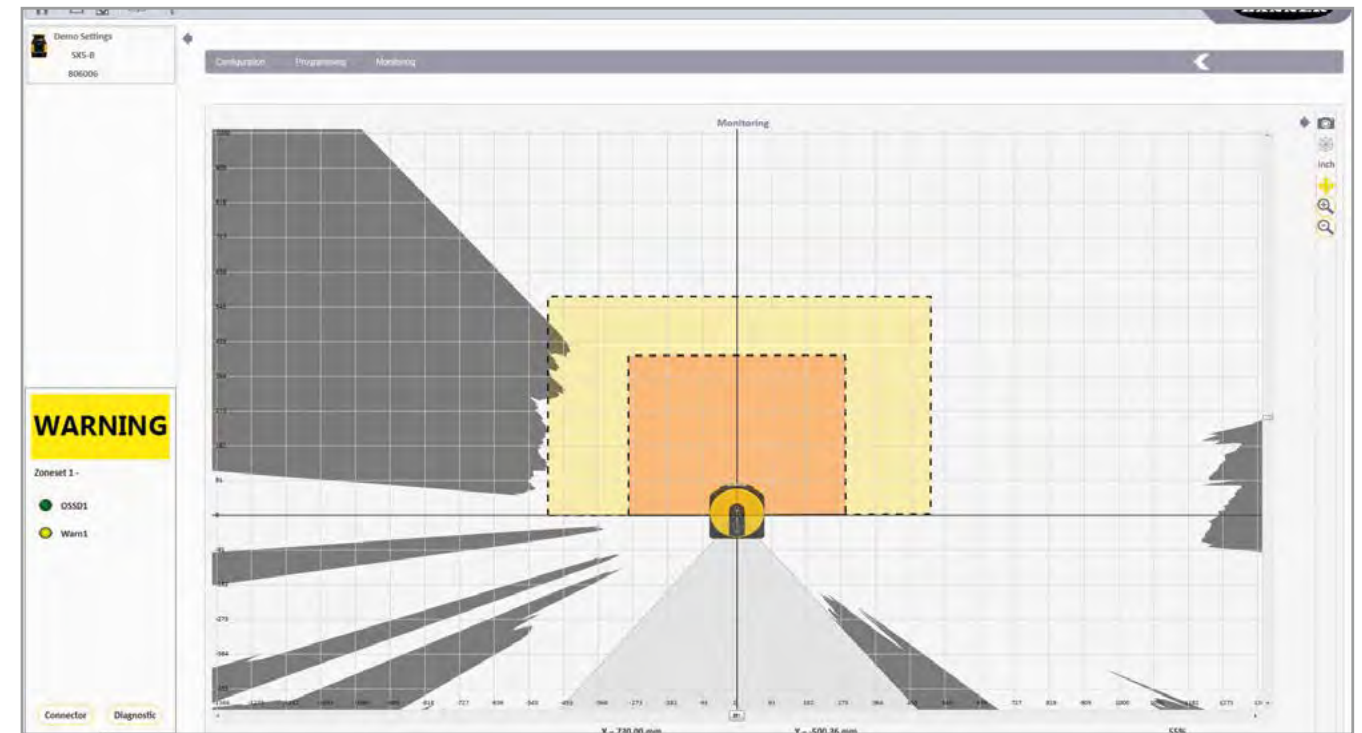

The software displays a graphic rendering of the monitored area and provides configuration and management tools, such as drop-down menus, function-specific worksheets, and more.

# Safety Scanner Fixed Applications

## Stationary area guarding

Stationary area guarding uses sensing fields such as safety or warning zones to continually sense an individual within a safeguarded area. Stationary area guarding can reduce or eliminate the possibility of a pass-through hazard that could result in an individual being exposed to unexpected machine startup or motion.

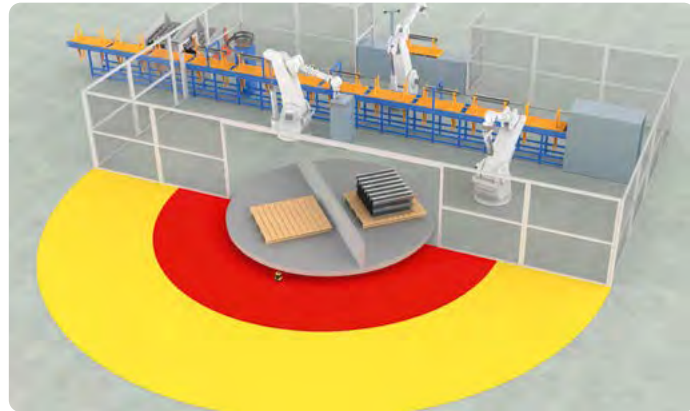

### Single-zone safeguarding

The safety scanner detects when a person approaches a hazard. When the person enters a warning zone, the hazardous motion is controlled safely. When the person enters the safety zone, the hazard is stopped.



### Multi-zone safeguarding

Up to three safety zones can be monitored simultaneously and independently. This way, safety in the entire plant is optimized, ensuring increased productivity and improved ergonomics in the entire plant.



### Multi-zone safeguarding via master-remote

Manage multiple areas with master-remote architecture. Multiple safety zones stop different parts of the dangerous machine, without the need of an external controller.

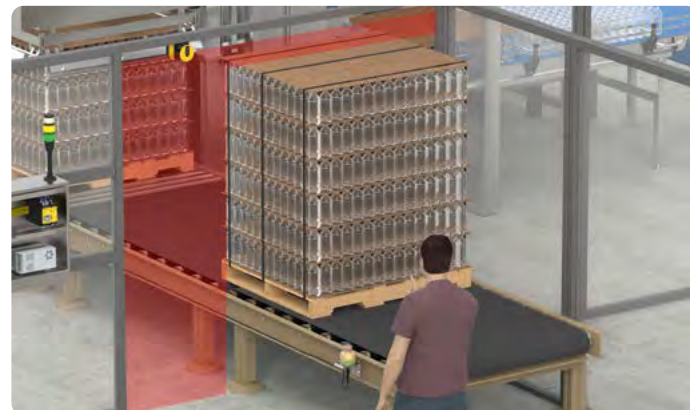

### Safeguarding with dynamic and partial muting

Muting sensors can be directly connected to the SX5, creating a tightly protected area around the muted object while muting is active. Each safety output can be configured with its own muting requirements.

# Safety Scanner Mobile Applications

## Mobile area guarding

On mobile applications, the SX5 monitors the area directly ahead of the vehicle using both the warning and the safety zones. The vehicle slows down if something is detected in the warning zone and the vehicle stops when something is detected in the safety zone. If the speed increases or decreases, alternate zone sets can be used to adjust for varying stopping distances.



### Automated guided vehicle collision avoidance

Warning and safety zones can be used to alert operators, slow down the vehicle, or stop it. Up to 70 different zones can be set and activated per position, speed and movement of the vehicle.



### Safe speed monitoring

Incremental encoders inputs can be directly read by the SX5 scanner in order to select the appropriate slow-down and stopping areas, based on the speed of the vehicle.

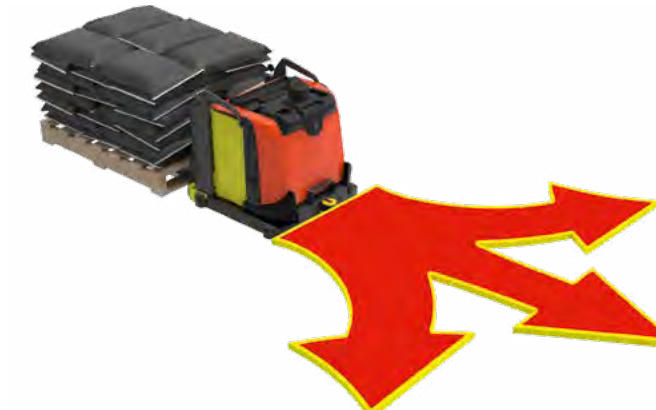

### Advanced measurement data for direct navigation



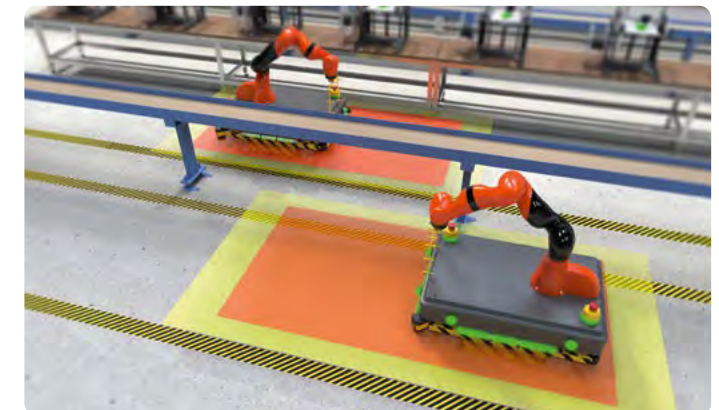





The SX5 has a direct transmission protocol over Ethernet. It can be used to read measurement data for vehicle navigation. Data includes active zone, I/O status, measured speed, intensity of beams, and diagnostic.













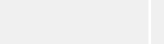

### Collaborative robot monitoring

Mobile collaborative robots (cobots) have built-in safety features that enable them to work alongside humans. Cobots can be programmed to slow down or stop when a human enters the warning or safety zone.

# Relay and Controller Selection Guide

	 GM/ES	 UM	 SM	 AT	 MMD
	p. 40	p. 40	p. 40	p. 40	p. 40
<b>Device Type</b>	Preconfigured Safety Relay Modules				
Self Testing Safety Device		✓			✓
Self Testing Safety Device with EDM Function		✓			✓
E-Stop	✓	✓			✓ (secondary function)
Rope Pull	✓	✓			✓ (secondary function)
Gate Switch (potential free contacts)	✓	✓			✓
RFID Gate Switch (OSSD contacts)		✓			✓
ISD Functionality					
  					
					
Network Access and View					
Safety Mat Monitoring			✓		
Two-Hand Control				✓	
Enabling Device	✓	✓			
Expandable					
Muting					✓
ON/OFF Delay					
Speed Monitoring					
<b>Safety Standard</b>	Cat. 4 PL e, per EN ISO 13849-1; SIL 3 per IEC 61508 and IEC 62061				
<b>Inputs</b>	1 NC and 1 NO (single or dual) 1 NC (single) 2 NC (dual)	1 NC (single) or 2 NC (dual) or 2 PNP	1 (or multiple in series) 4-wire safety mat	2 STB or buttons with complementary contacts	2 NC mutable (dual) and 2 NC SSI (dual)
<b>Safety Outputs</b>	2 NO, 3 NO, 4 NO	2 NO or 3 NO	4 NO	2 NO	2 PNP OSSD or 2 NO
<b>Maximum Safety Output Rating</b>	6A, 7A	7A	6A	6A	6A
<b>Auxiliary Outputs</b>	1 NC or 1 NC and 2 PNP	1 NC, depending on model	1 NC and 2 PNP		1 PNP or 1 NC
<b>Power Supply</b>	24 V AC/DC 115 V AC and 12-24 V DC or 230 V AC and 12-24 V DC	24 V AC/DC	115 V AC and 12-24 V DC or 230 V AC and 12-24 V DC	24 V AC/DC	24 V DC

	 SSM	 SR	 IM	 EM
	p. 40	p. 40	p. 40	p. 40
<b>Device Type</b>	Preconfigured Safety Relay Modules			
Self Testing Safety Device				
Self Testing Safety Device with EDM Function		✓	✓	
E-Stop				
Rope Pull				
Gate Switch (potential free contacts)				
RFID Gate Switch (OSSD contacts)				
ISD Functionality				
  				
				
Network Access and View				
Safety Mat Monitoring				
Two-Hand Control				
Enabling Device				
Expandable				✓
Muting				
ON/OFF Delay				OFF delay available
Speed Monitoring	✓			
<b>Safety Standard</b>	Cat. 4 PL e, per EN ISO 13849-1; SIL 3 per IEC 61508 and IEC 62061			
<b>Inputs</b>	2 PNP	2 NC (dual) or 2 PNP	2 NC (dual) or 2 PNP	1 NC (single) or 2 NC (dual)
<b>Safety Outputs</b>	2 NO	2 NO, 3 NO	2 NO, 3 NO	4 NO or 4 NO with delay
<b>Maximum Safety Output Rating</b>	4A	6A	6A	6A
<b>Auxiliary Outputs</b>	1 NC	1 NC	1 NC, depending on model	
<b>Power Supply</b>	24 V DC	24 V DC	24 V DC	24 V DC or 24 V AC/DC, depending on model

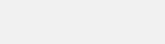
	 SC10	 SC26/XS26
	p. 42	p. 42
<b>Device Type</b>	Configurable Controllers	
Self Testing Safety Device	✓	✓
Self Testing Safety Device with EDM Function	✓	✓
E-Stop	✓	✓
Rope Pull	✓	✓
Gate Switch (potential free contacts)	✓	✓
RFID Gate Switch (OSSD contacts)	✓	✓
ISD Functionality	2 chains	8 chains
  	✓	✓
		✓ (XS Series only)
Network Access and View		✓
Safety Mat Monitoring	✓	✓
Two-Hand Control	✓	✓
Enabling Device	✓	✓
Expandable		✓
Muting	✓	✓
ON/OFF Delay	✓	✓
Speed Monitoring		
<b>Safety Standard</b>	Cat. 4 PL e, per EN ISO 13849-1; SIL 3 per IEC 61508 and IEC 62061	
<b>Inputs</b>	10	SC26: up to 26 XS26: up to 154
<b>Safety Outputs</b>	2x 3 NO	SC: 2 XS: up to 68
<b>Maximum Safety Output Rating</b>	6A each	0.5A each
<b>Auxiliary Outputs</b>	depends on configuration	depends on configuration
<b>Power Supply</b>	24 V DC	24 V DC

# Safety Relays and Controllers



Industrial safety controllers and relays provide an interface between safety devices and the machines and processes those devices monitor for a complete and easy-to-use safety control solution.



Safety controllers can be tailored for a wide variety of machines, including machines with multiple processes.

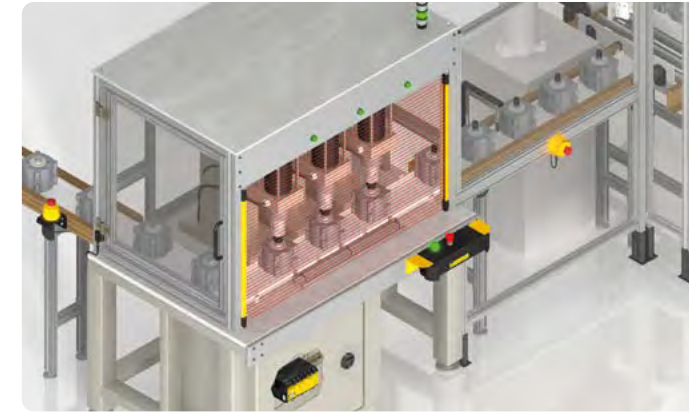

Configurable controllers monitor multiple safety devices, such as E-stop buttons, safety switches, safety light screens, two-hand controls, and rope pull switches.

## Safety Relays



Cost-effective for simple safety circuits

- Preset functionality: Configuration not required
- Safety inputs: 1
- Independently controlled safety outputs: 1; 4 to 7A
- Choose from a variety of models:
  - Universal input safety relays
  - E-stop monitoring safety relays
  - Muting safety relays
  - Safe speed monitoring relays
  - Safety mat relays
  - Safety extension relays
  - Interface relays

## Hybrid Safety Controller Plus 2 Safety Relays



Flexible and cost-effective solution for machines typically using 2 safety relays

- PC configurable: Flexible and easy-to-use
- Safety inputs: up to 10; up to 70 with ISD
- Independently controlled safety outputs: 2; 6A each
- Convertible safety inputs: 4
- Terminal LEDs for easy troubleshooting
- Industrial Ethernet
- Each output contains 3 NO redundant safety contacts

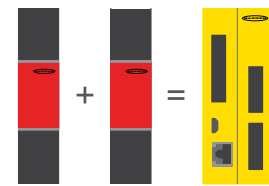

## Expandable Safety Controller



Expandable for complex safety applications where 3 or more safety relays are typically used

- PC configurable: flexible and easy-to-use
- Network accessible: configure and live view via an Ethernet connection (Ethernet enabled XS26 and SC26 models only)
- Safety inputs: 26 (base unit) up to 154
- Independently controlled safety outputs: up to 68; 0.5A to 6A each
- Convertible safety inputs: 8 (Base Unit) up to 40
- LCD screen for easy troubleshooting
- Industrial Ethernet

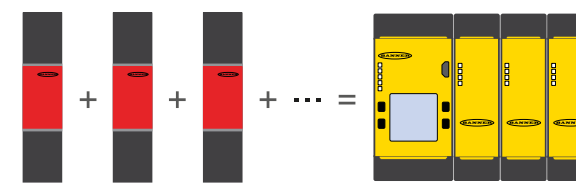

Connect safety devices easily to the safety controller

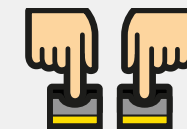
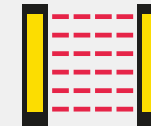

# Safety Controllers

## XS26 Expandable Safety Controller

26 to 154 Safety Inputs



Safety Outputs  
Safety Zones: 2 to 64

- 6A Relay 2 NO
- 0.5A Solid State

Industrial Ethernet  
EtherNet/IP Modbus TCP/IP EtherCAT

- Optional display screen allows local diagnostics for efficient troubleshooting
- Up to eight expansion I/O modules can be added as automation requirements grow or change
- Network accessible: configure and live view via optional Ethernet connection (Ethernet enabled XS26 and SC26 models only)

- Choose from six expansion module models with a variety of safety inputs, solid-state safety outputs and safety relay outputs
- Controller and input modules allow safety inputs to be converted to status outputs for efficient terminal use

## SC10 Safety Controller

10 Safety Inputs

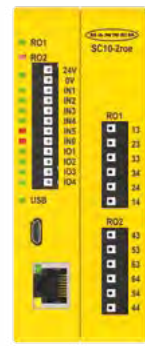

Safety Outputs  
Safety Zone 1: 6A Relay 3 NO

Safety Zone 2: 6A Relay 3 NO

- 10 safety inputs
- 4 safety inputs allowed to be converted to status outputs for efficient terminal use
- 2 redundant safety outputs
- LED indication next to each output
- Industrial Ethernet two-way communication
- Programmable via USB connection
- In-Series Diagnostic capable

Industrial Ethernet  
EtherNet/IP Modbus TCP/IP EtherCAT

## Easy to Configure and Integrate with a PLC

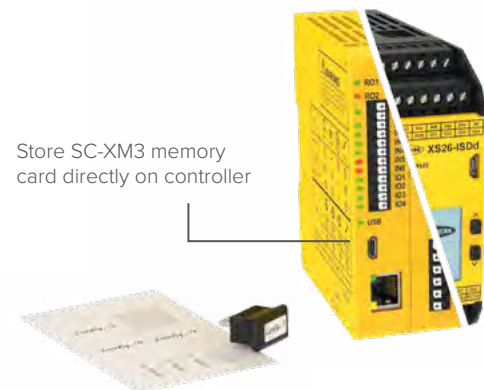

Store SC-XM3 memory card directly on controller

### SC-XM3 Fast Programming and Swapout

- Backup copy of configuration, password, network settings
- Download configuration without a PC
- Save time during panel build
- Fast swapout minimizes downtime



- Free Software
- Intuitive PLC Integration

# In-Series Diagnostics Functionality

In-Series Diagnostics allows you to connect up to 32 devices with one in-series connection and communicate directly with the most commonly used PLCs. Achieves up to CAT4, SIL3, PLe safety rating.

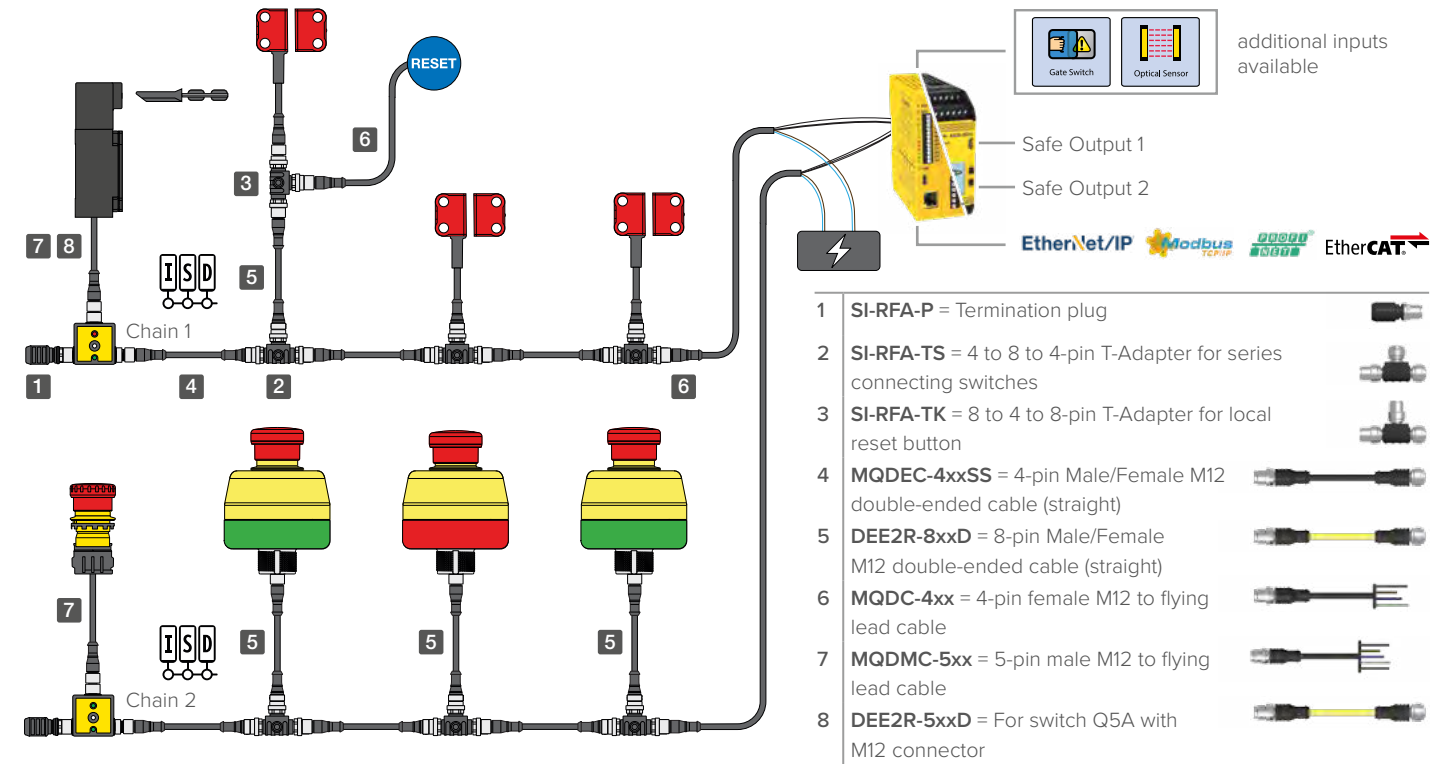

## Compatible Devices

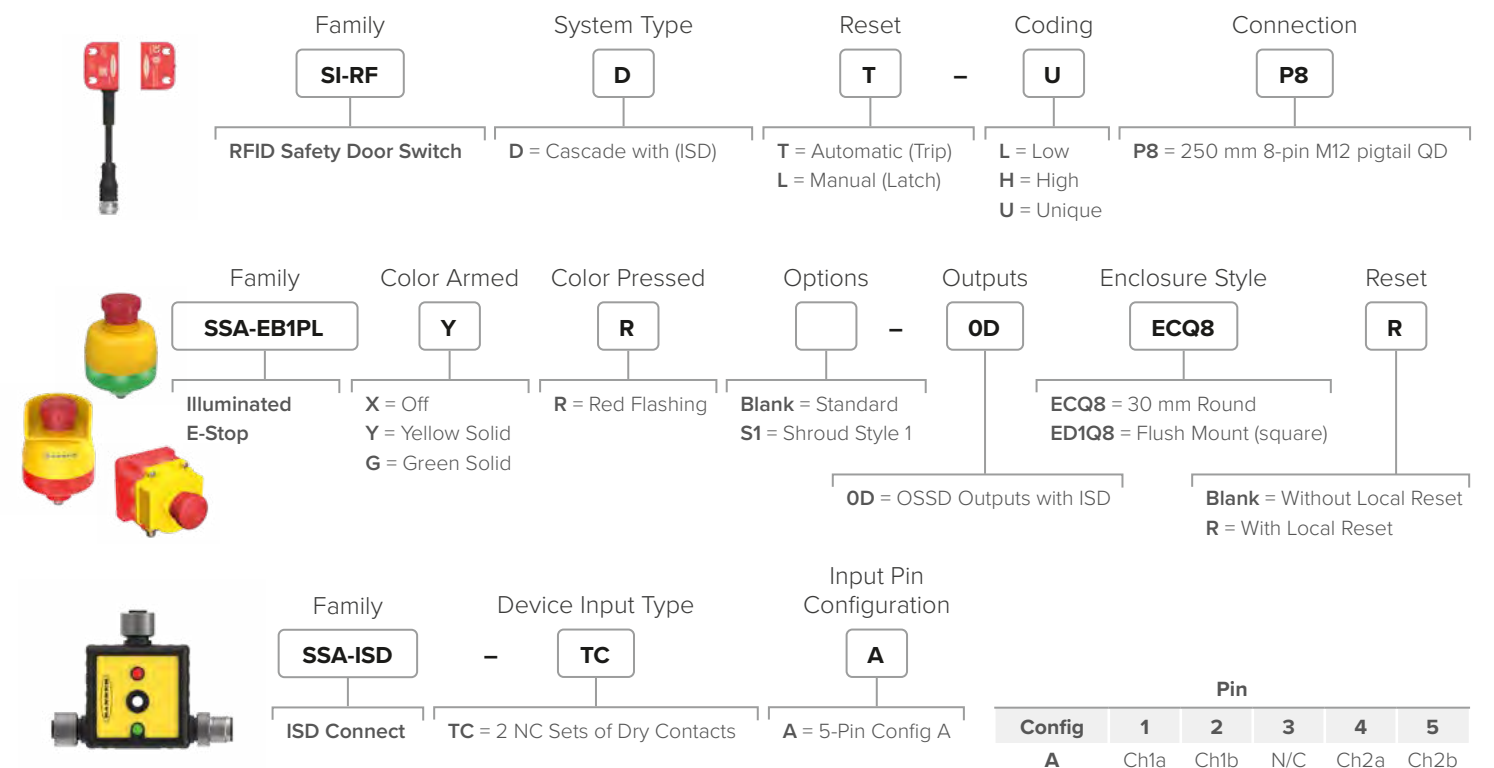

# Configure Your System in Minutes

The feature-rich SC10 and SC/XS26 safety controller software provides a seamless user interface for setting up and managing safety systems. The software features an intuitive icon-based, drag-and-drop user interface to reduce the learning curve and speed up commissioning.

- Complex configurations made easy
- Simulate configurations before implementation
- Auto configure Industrial Ethernet for remote monitoring and diagnostics
- Use the same software to access and configure the controller (Ethernet enabled XS26 and SC26 models only)

Start using the **free software** today. Go to [www.bannerengineering.com/safetycontroller](http://www.bannerengineering.com/safetycontroller)

## 1. Choose Controller



## 2. Equipment View

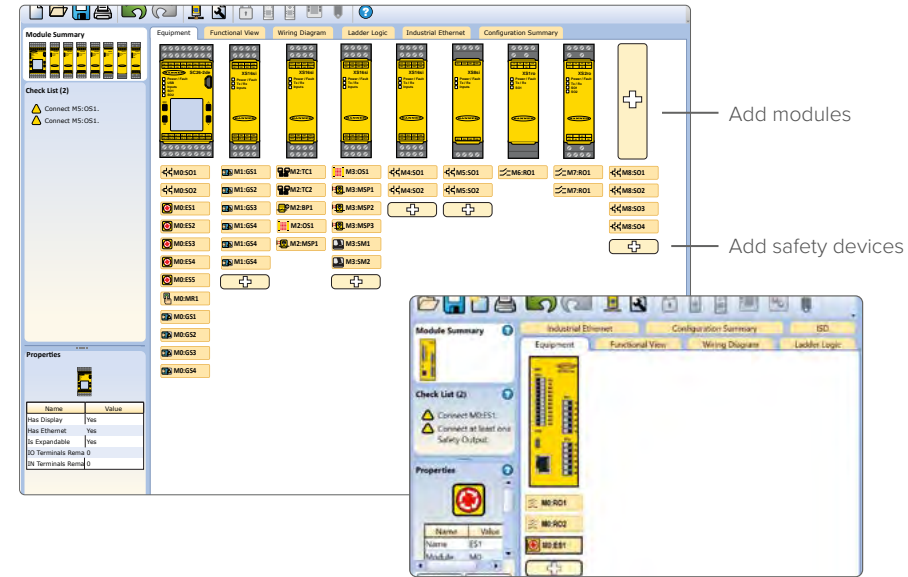

## 3. Add safety devices

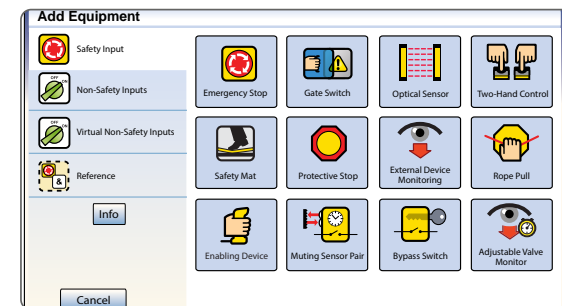

## 4. Select safety device properties

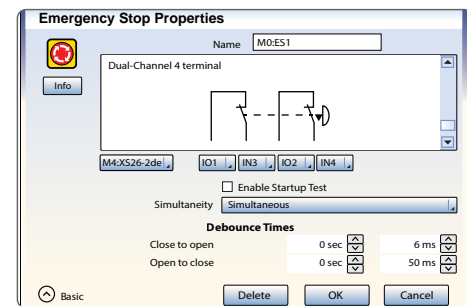

## 5. Add virtual non-safety inputs

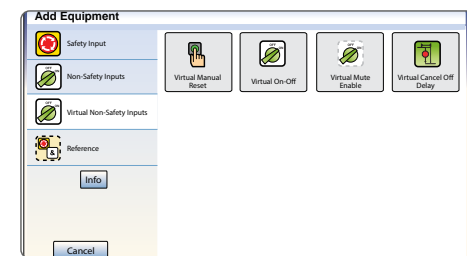

## Intuitive setup and PLC integration

- Expedite PLC Integration with Tag Export Feature
- Eliminates error-prone manual entries
- Import tags to PLC via .csv or .xml files
- Defines actionable In-Series Diagnostic data within the PLC
- For more information visit [bannerengineering.com/safetycontroller](http://bannerengineering.com/safetycontroller)

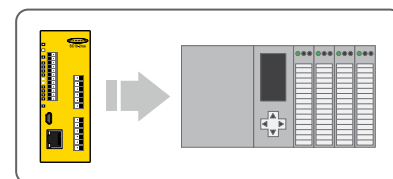

# System Software

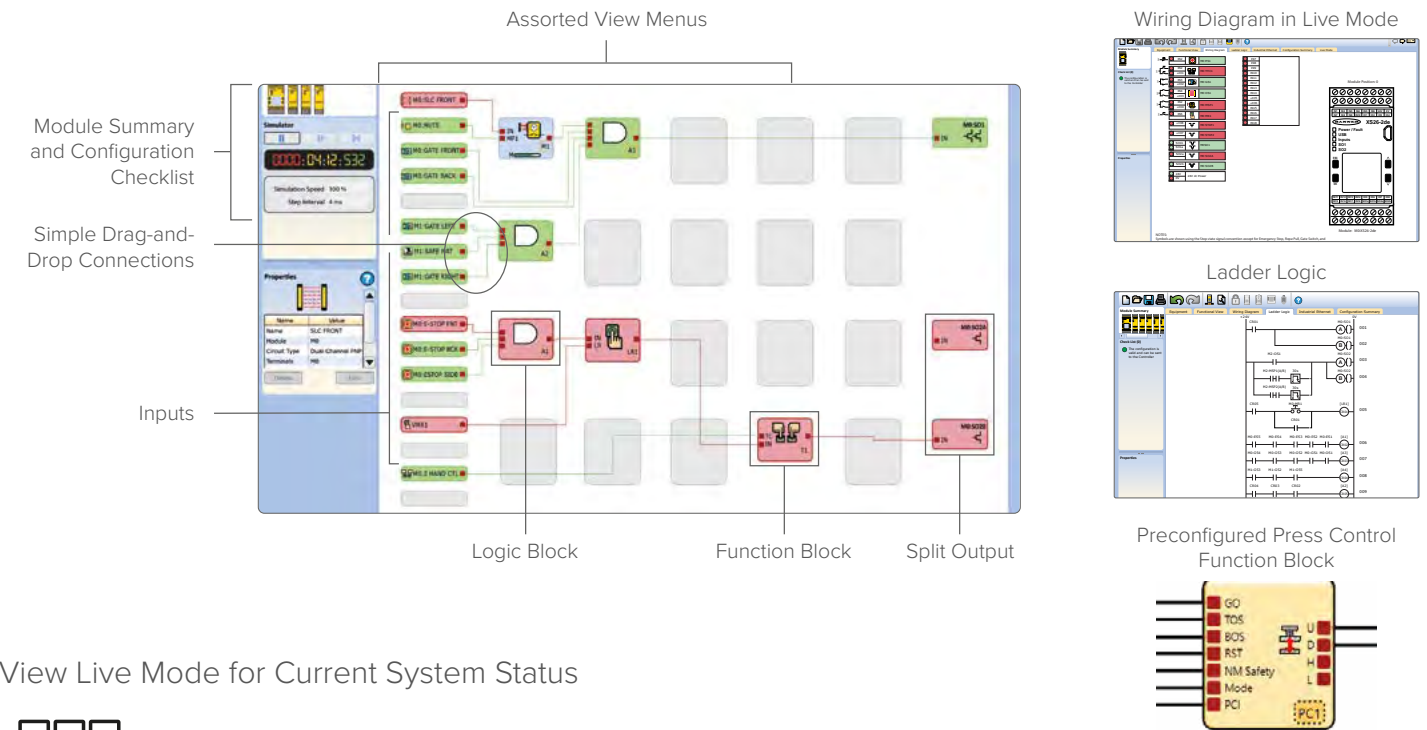

## View Live Mode for Current System Status

**Prevent Downtime:**

**Marginal** Alert to check Door 1 for misalignment before it causes downtime

**Warning** Alert to check E-Stop 1 for low voltage before it causes downtime

Terminator Plug	Name	Status	Alert	Actuator
1	Door 1	On	Marginal	Detected
2	Door 2	Off	Warning	Detected
3	Door 3	Off	Warning	Detected
	MD.Chain 1	Off	Warning	Detected
	MD.Chain 2	Off	Warning	Detected

**Terminator Missing; Actuator not Taught**

Chain:1	Device:1	Status	Alert	Actuator
1	Estop 1	On	Marginal	Detected
1	Estop 2	Off	Warning	Detected
1	Estop 3	Off	Warning	Detected

Troubleshooting Made Easy:

Terminator missing

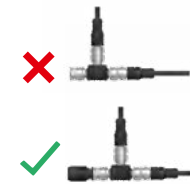

Actuator not taught



Up to 32 ISD safety devices in any order per chain

Reduce Downtime: Local operator guidance to activated E-Stop

Additional uses for ISD

- Rotation/Indexing
- Tool Identification
- Position Verification

# Safety Relays

## E-Stop and Guard Safety Modules

Supply Voltage	Inputs	Safety Outputs	Aux. Outputs	Output Rating	Output Response Time	Models
24 V AC/DC	1 NC & 1 NO (single or dual)	2 NO	–	6 A	35 ms	<b>GM-FA-10J</b>
	1 NC (single) or 2 NC (dual)	3 NO	–	6 A	25 ms	<b>ES-FA-9AA</b>
	1 NC (single) or 2 NC (dual)	2 NO	1 NC	7 A	25 ms	<b>ES-FA-11AA</b>
	1 NC (single)	3 NO	1 NC	6 A	35 ms	<b>ES-FA-6G</b>
115 V AC & 12-24 V DC	1 NC (single) or 2 NC (dual)	4 NO	1 NC & 2 PNP	6 A	25 ms	<b>ES-UA-5A</b>
230 V AC & 12-24 V DC						<b>ES-VA-5A</b>

## Universal Safety Input Modules

Supply Voltage	Inputs	Safety Outputs	Aux. Outputs	Output Rating	Output Response Time	Models
24 V AC/DC	1 NC (single) or 2 NC (dual) or 2 PNP	3 NO	–	6 A	25 ms	<b>UM-FA-9A</b>
		2 NO	1 NC	7 A		<b>UM-FA-11A</b>

## Modules for Specific Monitoring Applications

Supply Voltage	Inputs	Safety Outputs	Aux. Outputs	Output Rating	Output Response Time	Models
115 V AC & 12-24 V DC	1 (or multiple in series) 4-wire safety mat	4 NO	1 NC & 2 PNP	6 A	50 ms	<b>SM-GA-5A</b>
230 V AC & 12-24 V DC					35 ms	<b>SM-HA-5A</b>
24 V AC/DC	1 (2x2 complementary) for two-hand control	2 NO	–	6 A	35 ms	<b>AT-FM-10K</b>

## Muting Modules

Supply Voltage	Input Device	Inputs	Safety Outputs	Aux. Outputs	Output Rating	Output Response Time	Models
24 V DC	Electromechanical & solid state	2 NC muteable (dual) & 2 NC SSI (dual)	2 PNP OSSD	1 PNP	0.5 A	10 ms	<b>MMD-TA-12B</b>
			2 NO	1 NC	6 A	20 ms	<b>MMD-TA-11B</b>

## Safe Speed Monitoring Modules

Supply Voltage	Inputs	Safety Outputs	Aux. Outputs	Output Rating	Ranges (impulses/minute)	Models
24 V AC/DC	2 PNP	2 NO	1 NC	4 A	5-40, 35-340, 300-2700, 1200-10500	<b>SSM-FM-11A10</b>
					10-80, 80-650, 600-5300, 2400-20000	<b>SSM-FM-11A20</b>

## Interface Modules

Supply Voltage	Inputs	Safety Outputs	Aux. Outputs	Output Rating	Output Response Time	Models
24 V DC	2 NC	3 NO	–	6 A	20 ms	<b>SR-IM-9A</b>
		2 NO	1 NC			<b>SR-IM-11A</b>
		3 NO	–			<b>IM-T-9A</b>
		2 NO	1 NC			<b>IM-T-11A</b>

# Safety Controllers

## Non-expandable Safety Controllers

Description	Housing H x W x D (mm)	Inputs/Convertible	Independently Controlled Safe Outputs	Maximum Safety Output Rating	Features	Models (24 V DC)
SC26 Safety Controller	110 x 45 x 128	26/8	2 Dual Channel PNP	0.5A at 24 V DC	Display	<b>SC26-2d</b>
					Display, Ethernet	<b>SC26-2de</b>
					–	<b>SC26-2</b>
SC10 Safety Controller	115 x 45 x 100	10/4	2 Dual Channel Relays	2x 3 NO: 6A 250 V AC/24 V DC	Ethernet	<b>SC26-2e</b>
					ISD, Ethernet	<b>SC10-2roe</b>

## Expandable Safety Controllers

Description	Housing H x W x D (mm)	Inputs/Convertible	Independently Controlled Safe Outputs	Maximum Safety Output Rating	Features	Models (24 V DC)
XS26 Expandable Safety Controller	110 x 45 x 128	26/8	2 Dual Channel PNP	0.5A at 24 V DC	Display	<b>XS26-2d</b>
					Display, Ethernet	<b>XS26-2de</b>
					–	<b>XS26-2</b>
					Ethernet	<b>XS26-2e</b>
Safety Input Module	W: 22.5 mm	8/2	–	–	–	<b>XS26-ISDd</b>
		16/4	–	–	–	<b>XS8si</b>
Safety Output Module	W: 22.5 mm	–	2 Dual Channel PNP	0.75A at 24 V DC	–	<b>XS16si</b>
		–	4 Dual Channel PNP	0.5A at 24 V DC	–	<b>XS2so</b>
Safety Relay Output Module	W: 22.5 mm	–	1 Dual Channel Relay	6A; 2 NO, 1 NC Aux (2.5A)	–	<b>XS4so</b>
		–	2 Dual Channel Relays	6A; 2x 2 NO, 2x 1 NC Aux (2.5A)	–	<b>XS1ro</b>
Network Expansion Module	W: 22.5 mm	–	–	–	Ethercat	<b>XS2ro</b>
						<b>XSeCAT</b>

## Expansion Modules

Supply Voltage	Inputs	Safety Outputs	Output Rating	Aux. Outputs	Output Response Time	Delay	Models
24 V DC	1 NC (single) or 2 NC (dual)	4 NO	6 A	–	20 ms	–	<b>EM-T-7A</b>
				–	35 ms	–	<b>EM-F-7G</b>
24 V AC/DC	1 NC (single)	4 NO w/delay	6 A	–	–	0.5 s	<b>EM-FD-7G2</b>
				–	–	1.0 s	<b>EM-FD-7G3</b>
				–	–	2.0 s	<b>EM-FD-7G4</b>

## Accessories



**SC-USB2**  
USB Cable



**SC-XM2**  
Memory Card for XS26 and SC26



**SC-XM3**  
Memory Card for SC10



**SC-XMP2**  
SC-XM2/3 Configuration Tool

# Safety Switches Selection Guide



**SI-MAG**



**SI-RF**



**SI-LS**



**SI-QS**



**SI-GL42**



**SI-LS42**



**SI-LS83**



**SI-HG63**



**SI-HG80**

	SI-MAG	SI-RF	SI-LS	SI-QS	SI-GL42	SI-LS42	SI-LS83	SI-HG63	SI-HG80
	p. 50	p. 52	p. 50	p. 50	p. 50	p. 50	p. 50	p. 50	p. 50
<b>Device Type</b>	Magnetic	RFID	Mechanical		Mechanical			Hinge	
<b>Switch Style</b>	Non-Contact	Non-Contact	Separate Actuator	Separate Actuator	Separate Actuator	Separate Actuator	Limit	Hinge	Hinge
<b>Non-Locking</b>	✓	✓	✓	✓			✓	✓	✓
<b>Locking</b>					✓	✓			
<b>Position</b>	✓	✓					Plunger, Roller, Spindle-mount, Lever		
<b>Contacts</b>	1 NC, 1 NO	OSSD PNP	2 NC, 1 NO 1 NC, 1 NO 2 NC	1 NC, 1 NO 2 NC 2 NC, 1 NO 1 NC	1 NO 1 NC 1 NC, 1 NO 2 NC 2 NC, 1 NO 3 NC	1 NC, 1 NO 2 NC, 1 NO 1 NC 2 NC 3 NC	1 NC, 1 NO 2 NC 2 NC, 1 NO	2 NC, 1 NO	1 NC, 1 NO
<b>Locking or Unlocking Power</b>					24 V AC/DC	24 V AC/DC 110 V AC/230 V AC			
<b>Straight Rigid Inline</b>			✓		✓	✓			
<b>Rigid Inline</b>			✓	✓	✓				
<b>Flexible Inline</b>			✓	✓	✓	✓			
<b>High-Force Accessory</b>				✓					
<b>LED Status Indication</b>		✓							
<b>Cascadable</b>		✓							
<b>ISD (In-Series Diagnostics)</b>		✓			Compatible with ISD connect			Compatible with ISD connect	
<b>Coding level/ Manipulation protection EN ISO 14119</b>	Low coding	Unique/Low/High coding	Low coding	Low coding	Low coding	Low coding	Uncoded	Uncoded	Uncoded
<b>Housing Material</b>	Plastic	Plastic	Plastic	Plastic	Head: Metal Body: Plastic	Plastic	Plastic	Metal	Metal
<b>Locking</b>					Spring lock Solenoid lock	Spring lock Solenoid lock			
<b>Actuation Extraction Force</b>			10 N	10 N High-Force models: adjust. from 50-100 N	1500 N when locked	2000 N when locked			
<b>Resettable Switching Point</b>								✓	

# Safety Switches



The SI-GL42D fail-safe guard locking switch has several guard locking options: manual, spring-to-lock, or power-to-lock. The safety switch can manually be unlocked using a tool in case of maintenance work. Emergency or escape release are additional functions that allow for quick intervention when required. In spring-to-lock models, the guard is locked by spring force. To unlock, the solenoid must be energized. In power-to-lock models, the guard is locked when the solenoid is energized. To unlock, power must be switched off.

## Hinge Switches

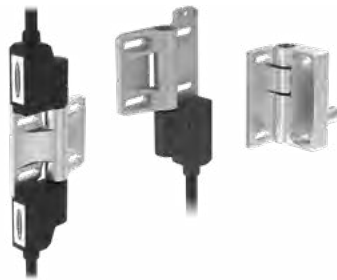

- One-piece sensor and actuator with hinge function
- Fast installation and setup with repositionable safety switch point
- Stainless steel and IP69 available
- Matching hinges without sensing available for additional door support
- Available with up to 270° safety switch point operation range

## Non-Contact Switches



- Two-piece design where sensor and actuator do not contact
- Coded magnets/tags minimize the potential for intentional defeat
- A single pair can achieve up to Category 4/PL safety rating
- Accommodating to misalignment
- Non contact solution minimizes device wear and tear, even in applications with persistent use
- Up to IP69 solutions available

## Mechanical Switches



- Two-piece design with mechanical operator feedback
- Flexible actuator options for misalignment
- Rotatable heads for flexible installation
- Mechanically coded actuator to minimize tampering
- Up to 15N latching force to reduce downtime due to vibrating doors
- One-piece limit switches available

## Locking Switches



- Two-piece design with up to 2000N locking force for safety or process critical applications
- Flexible actuator options for misalignment
- Rotatable heads for flexible installation
- Mechanically coded actuator to minimize tampering
- Up to 15N latching force to position door prior to locking

## Limit Switches



- Cost effective one piece sensor
- No actuator allows for fewer alignment issues
- Hideable making them more tamper resistant
- Rotating head and top or side engagement allows for eight different actuator positions
- Design meets positive opening requirements for safety switches

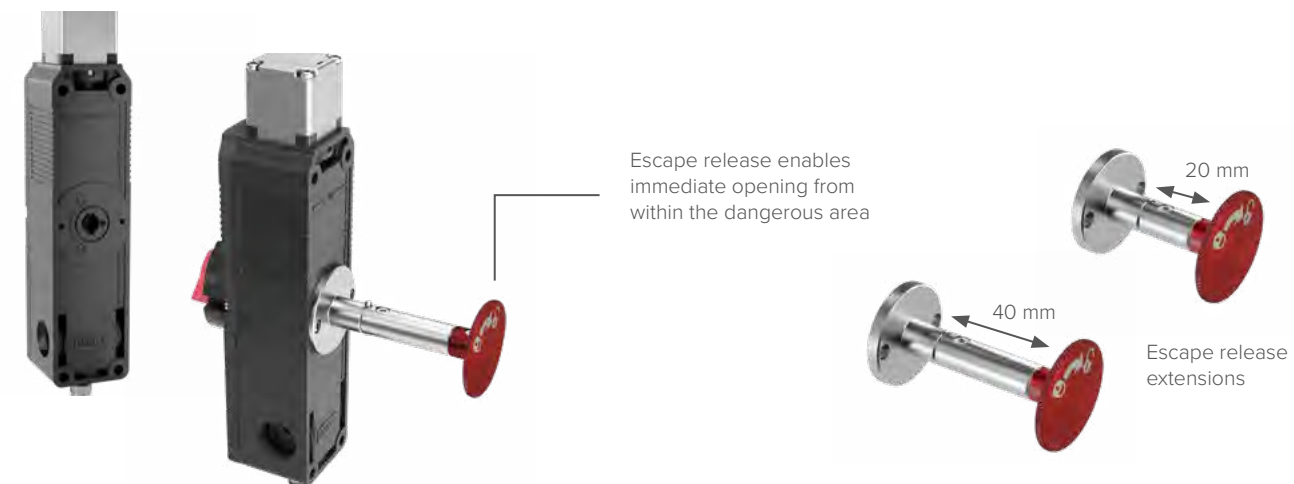

# Non-Contact RFID Safety Switches



Safety switches respond when a mechanical guard is opened. They feature “positive opening” contacts for high reliability regardless of environmental conditions and withstand attempts to override the switch and defeat the system.

RFID SI-RF Switches



Single door RFID non-contact gate/door sensing solution

- Basic, medium, and high tamper resistance
- Misalignment tolerance of 10 mm
- Resistant to high vibration and operations with metallic shavings
- On-board LED for status and diagnostics

RFID SI-RF Switches – Cascade



Multiple door RFID non-contact gate/door sensing solution

- Basic, medium, and high tamper resistance
- Misalignment tolerance of 10 mm
- Resistant to high vibration and operations with metallic shavings
- On-board LED for status and diagnostics
- Connect up to 32 sensors in cascade while maintaining the highest level of safety
- 4-pin QD connections for cost-effective, simple, error-free installation
- RFID cascade with In-Series Diagnostics available



# Enabling Devices



A two-hand control safeguarding system will prevent the operator from approaching the machine while a hazard is present. Duo-Touch Run Bar provides an all-in-one solution.

Handheld grip-styled switches are used for manual control of machine functions including visual observations, minor adjustments, calibration, and more.

## Two-Hand Control

STB Self-Checking Touch Buttons

Connection	Touch Surface Material	Output	Power Supply	Models
2 m cable	Polyetherimide (PEI)	Solid-state 2 Complementary PNP (1 ON, 1 OFF)	10-30 V DC	<b>STBVP6</b>
4-pin M12 QD				<b>STBVP6Q5</b>
2 m cable		E/M Relay 2 Complementary SPST (1 NC, 1 NO)	20-30 V AC/DC	<b>STBVR81</b>
5-pin M12 QD				<b>STBVR81Q6</b>



STB buttons include yellow field cover to prevent unintended switching. To comply to safety standards, STB buttons must be used with appropriate Two-Hand control modules, SC26, XS26 or SC10 Safety Controller or comparable Type IIIC Two-Hand system.

DUO-TOUCH Two-Hand Control Kits with STB Touch Buttons  
2 NO safety outputs, no auxiliary outputs, 24 V AC/DC, Cat 4 and Type IIIC

Module	IP Rating	STB Buttons (2 pieces)	IP Rating	Connection	Kits
AT-FM-10K	IP20	STBVP6	IP66	2 m cable	<b>ATK-VP6</b>
		STBVP6Q5		4-pin M12 QD	<b>ATK-VP6Q5</b>



Kit does not include run bar

## Two-Hand Control Run Bars

Run Bars with STBVP6

Models	IP Rating	Models	IP Rating	Connection	E-Stop
<b>STBVP6-RB1</b>	IP20	STBVP6-RB2	IP65	Terminal strip	Not included
<b>STBVP6-RB1Q8</b>		STBVP6-RB2Q8		8-pin 7/8 QD	Not included
<b>STBVP6-RB1E02</b>		STBVP6-RB2E02		Terminal strip	SSA-EBM-02L



## Enabling Devices

ED1G Enabling Devices

Contact Configuration	Momentary Push Button	Models
2 NO & 1 NC Aux	–	<b>ED1G-L21SM-1N</b>
2 NO & 1 NC Aux	1 NO	<b>ED1G-L21SMB-1N</b>
2 NO	2 NO	<b>ED1G-L20MB-1N</b>



# Safety Switches

## Magnetic Switches

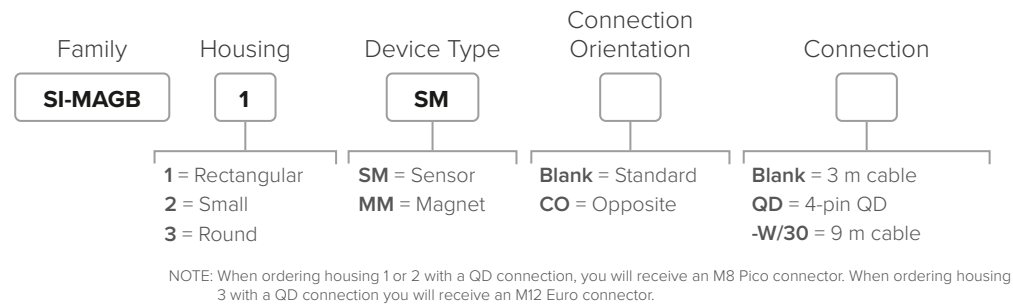

## Hinge Switches

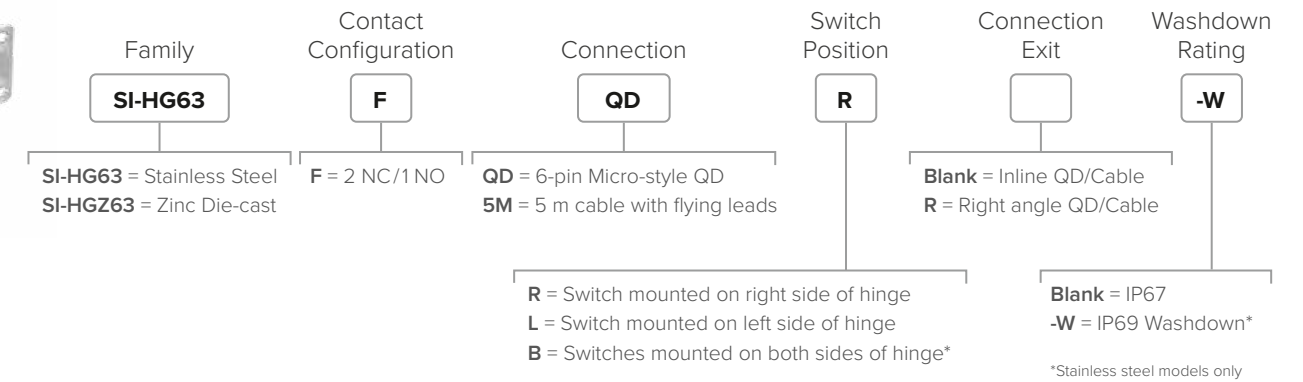

## RFID Switches

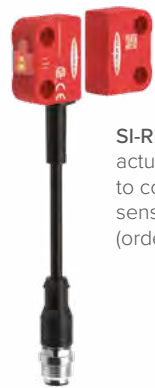

SI-RF-A or SI-RF-A2 actuator is required to complete a sensor solution (ordered separately)

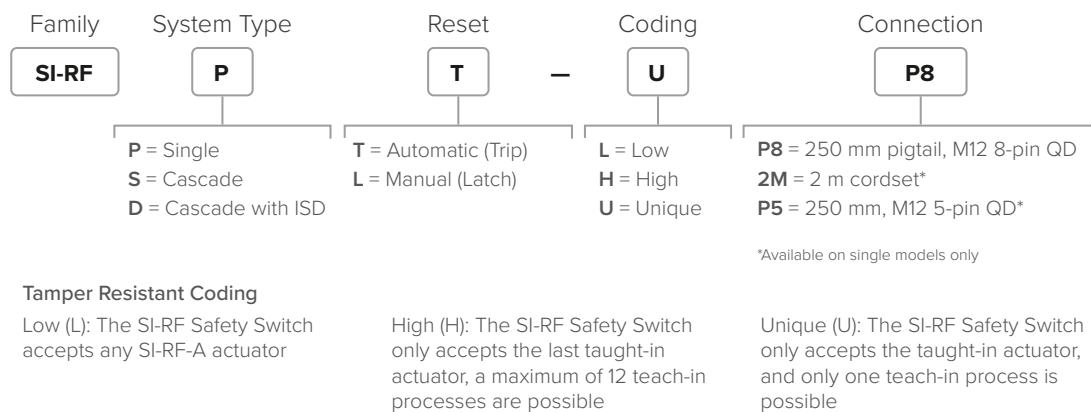

## Mechanical Switches

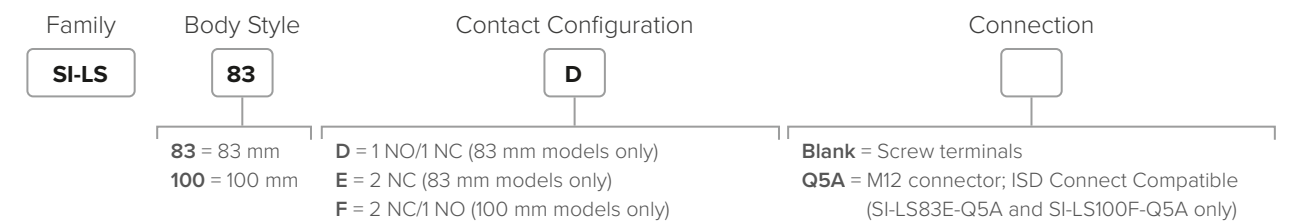

## Actuators



**SI-QS-SSA-2**  
Straight Rigid Inline Actuator



**SI-QS-SSA-3**  
Right-Angle Rigid Inline Actuator



**SI-QS-SSU**  
Flexible Inline Actuator

## Brackets



**SI-HG80DQD**  
Inline QD Fitting



**SI-HG80DQDR**  
Right-angle QD Fitting



**SI-HG80A**  
Blank Hinge



**SI-HG63A**  
Blank Hinge

## Adaptor Cable



**MQEAC-601-Q5A**  
SI-HG63 to ISD Connect Adaptor Cable

# Safety Switches

## Locking Switches

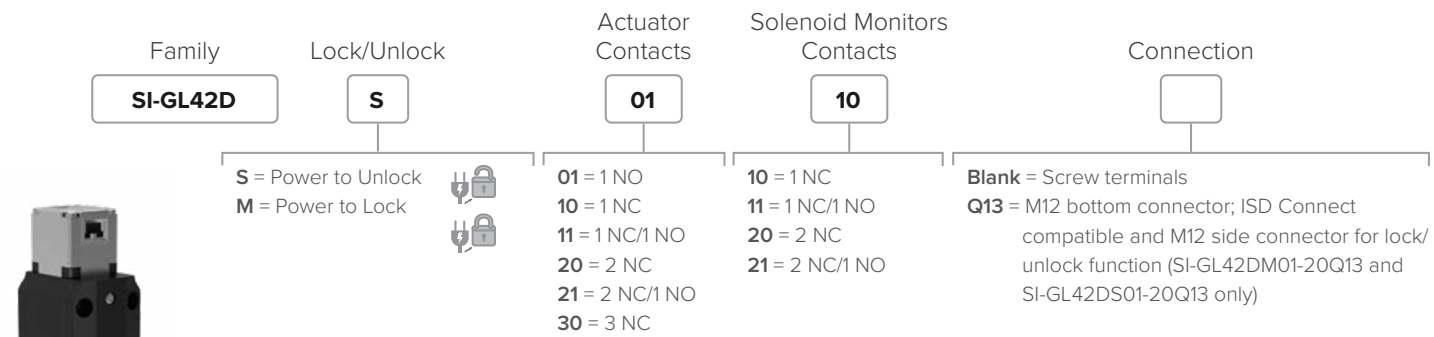

## Actuators



## Unlock Mechanism



## Locking Switches

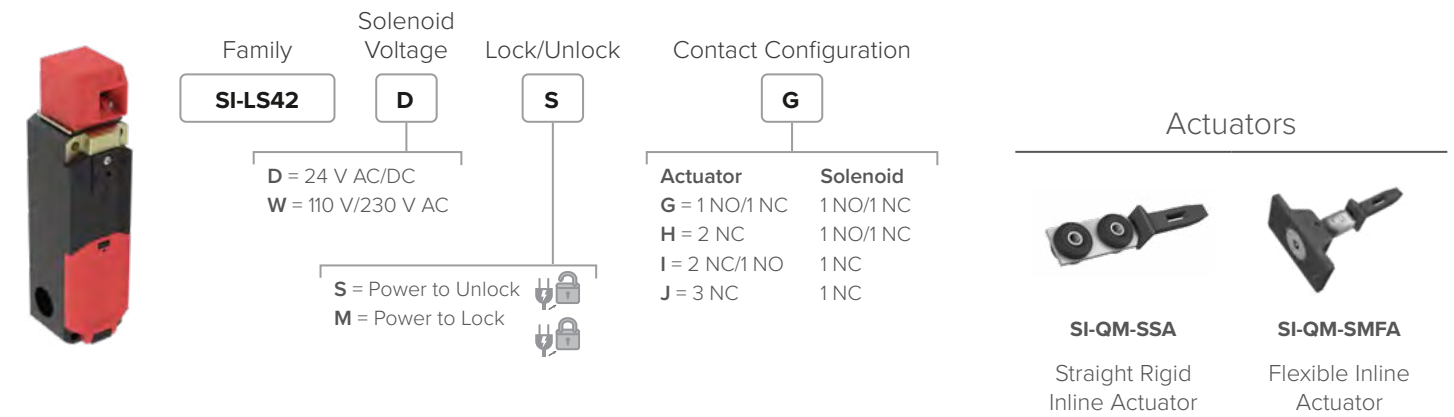

## Limit Switches

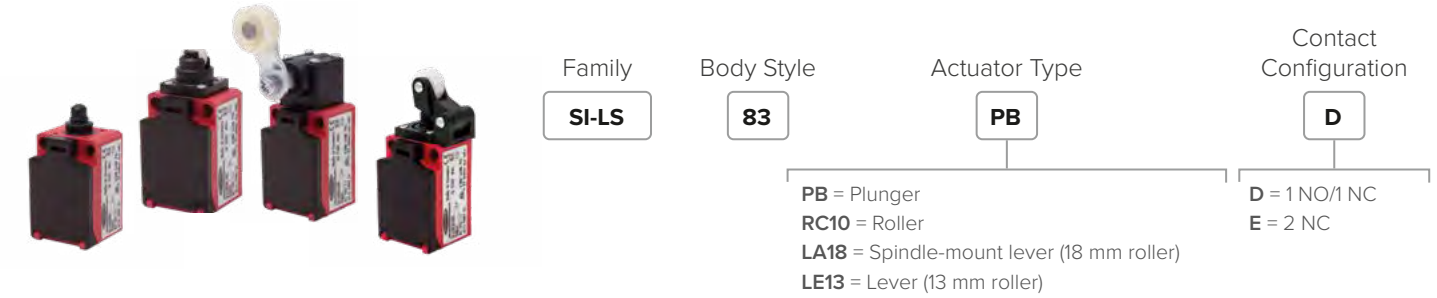

# E-Stop Devices Selection Guide



SSA-EBM SSA-EB

	p. 60	p. 60
Panel Mount Emergency Stop Buttons		
E-Stop	✓	✓
Rope Pull		
Button Size (mm)	40 mm	40, 44, 60 mm
Illuminated Housing		
Illuminated Button		✓
Release	✓	✓
Lock/Unlock Button		✓ (SSA-EB1M only)
Rope Length (m)		
Rope Connection		
ISD (In-Series Diagnostics)		
Safety Contacts	1 NC 2 NC	1 NC 2 NC 3 NC 4 NC
Auxiliary Contacts	1 NO	1 NO 2 NO
OSSD Outputs		
Connection	Screw terminals	Screw terminals
Panel/Bracket Hole (mm)	22 mm	30 mm



SSA-EB1PL SSA-EB1P SSA-EB1M

	p. 60	p. 60	p. 60
Emergency Stop Buttons			
E-Stop	✓	✓	✓
Rope Pull			
Button Size (mm)	40, 60 mm	40, 60 mm	44 mm
Illuminated Housing	✓		✓
Illuminated Button	✓	✓	
Release	✓	✓	✓
Lock/Unlock Button			✓
Rope Length (m)			
Rope Connection			
ISD (In-Series Diagnostics)	✓	✓	
Safety Contacts	1 NC 2 NC 4 NC	1 NC 2 NC 4 NC	1 NC 2 NC 4 NC
Auxiliary Contacts	1 NO 2 NO	1 NO 2 NO	1 NO 2 NO
OSSD Outputs	✓	✓	
Connection	M12 or Screw terminals	M12 or Screw terminals	M12 or Screw terminals
Panel/Bracket Hole (mm)	30 mm	30 mm	



RP-RM83 RP-LS42 RP-QM(T)72 RP-LM40 RP-QM90

	p. 61	p. 61	p. 61	p. 61	p. 61
Rope Pull Emergency Stop Switches					
E-Stop	✓	✓			
Rope Pull	✓	✓	✓ (only stop control)	✓ (only stop control)	✓
Button Size (mm)	32 mm	32 mm			
Illuminated Housing					
Illuminated Button					
Release	✓				
Lock/Unlock Button					
Rope Length (m)	38 m 70 m	25 m 37.2 m 75 m	6 m 12 m 20 m	6 m	50 + 50 m
Rope Connection	Built-in turnbuckle or ring connection	Built-in turnbuckle or ring connection	Ring connection	Ring connection	Ring connection
ISD (In-Series Diagnostics)					
Safety Contacts	2 NC	2 NC	2 NC 4 NC	2 NC	2 NC
Auxiliary Contacts	2 NO	2 NO	1 NO (specific models)		2 NO
OSSD Outputs					
Connection	Screw terminals	Screw terminals	Screw terminals	Screw terminals	Screw terminals
Panel/Bracket Hole (mm)					



## Related Product: ISD Connect

- Connects a non-ISD-enabled safety device with 2 normally closed sets of contacts, such as a panel-mount E-stop or safety switch, to an ISD chain
- IP67-rated and installs easily, with no assembly or individual wiring required
- Access diagnostic data, prevent system faults, and reduce equipment downtime of non-ISD devices
- Built-in indication for input device and ISD status

# E-Stop Devices

## E-Stop Buttons\*

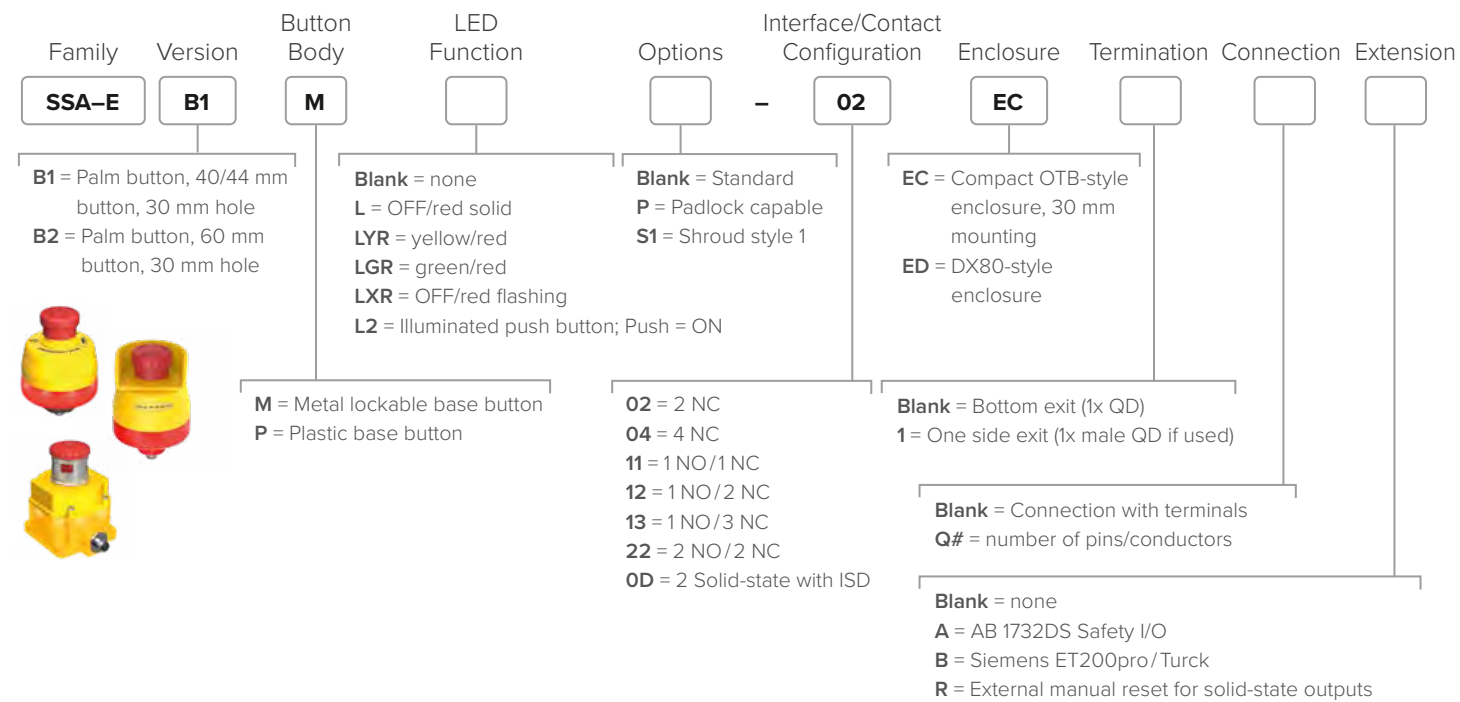

## Accessories

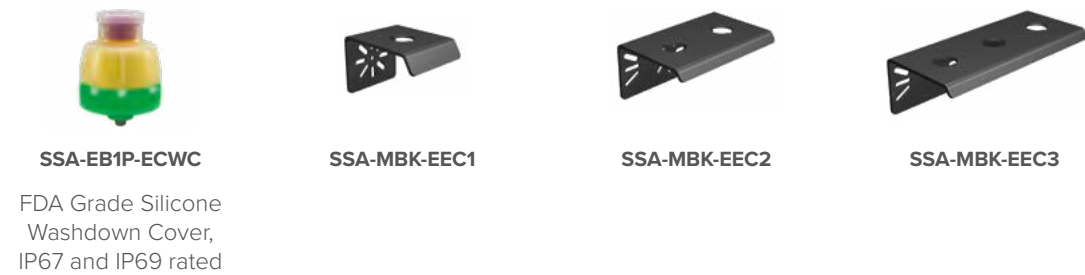

## Panel Mount E-Stop Buttons\*

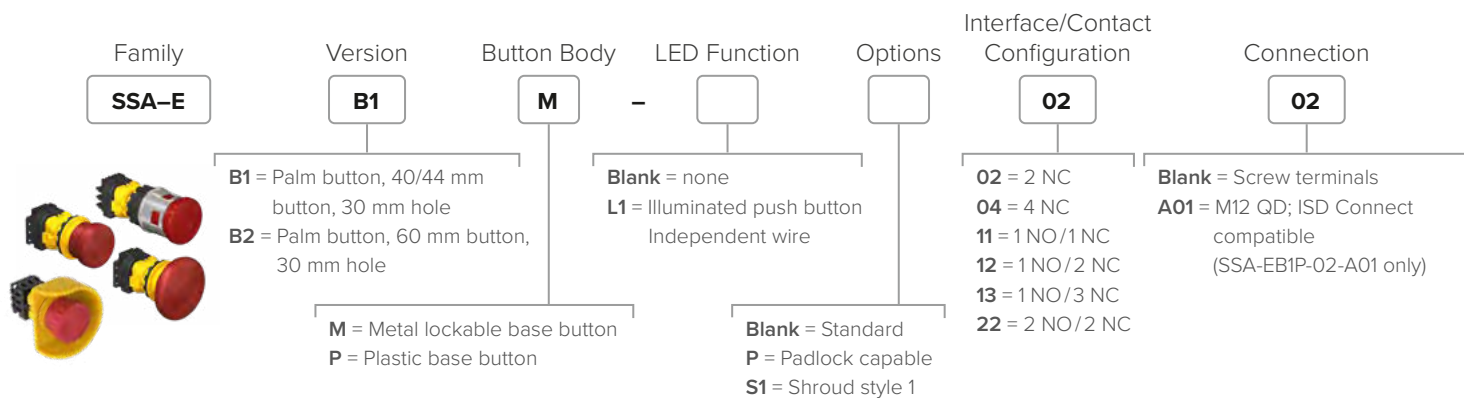

## E-Stop Button Kits

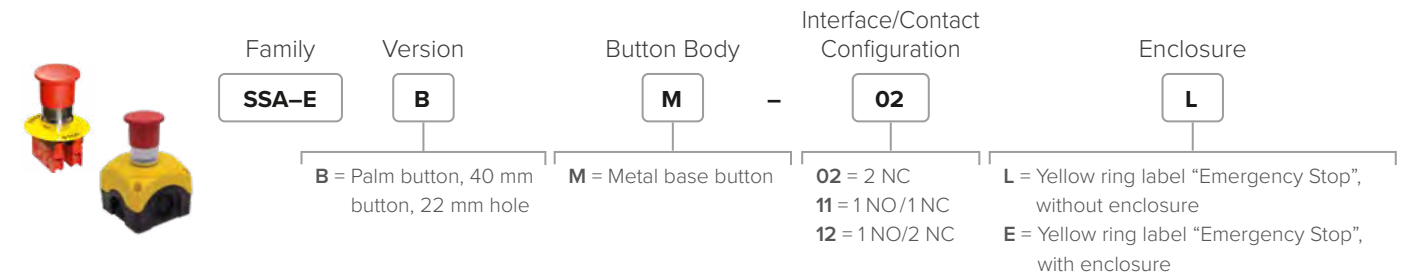

## Rope Pull E-Stop Devices

Maximum Rope Length	Rope Connection	Safety Contacts	Auxiliary Contacts	Actuation	Housing Material	Models
38 m	Built-in turnbuckle	2 NC in	2 NO in	Latch	Metal, IP67	RP-RM83F-38LT
75 m						RP-RM83F-75LT
38 m	Ring connection					RP-RM83F-38LR
75 m						RP-RM83F-75LR
25 m	Built-in turnbuckle	RP-LS42F-25LE				
37.5 m		RP-LS42F-38LE				
75 m		RP-LS42F-75LE				

Note: For auxiliary status output models add E to the end of the model number (example, RP-RM83F-38LTE)

## Rope Pull Switches

Maximum Rope Length	Rope Connection	Safety Contacts	Auxiliary Contacts	Actuation	Housing Material	Models
25 m	Ring connection	2 NC in	2 NO in	Latch	Plastic	RP-LS42F-25L
37.5 m						RP-LS42F-38L
75 m						RP-LS42F-75L
25 m	Built-in turnbuckle					RP-LS42F-25LF
37.5 m		RP-LS42F-38LF				
75 m		RP-LS42F-75LF				
6 m	-	2 NC in	-	Latch	Metal	RP-QM72D-6L
12 m						RP-QM72D-12L
20 m						RP-QM72D-20L
12 m	-	4 NC in	1 NO in	-	Metal	RP-QMT72F-12L
12 m						RP-QMT72E-12L
6 m	-	2 NC in	-	Trip	Metal	RP-LM40D-6
6 m						RP-LM40D-6L
100 m (50 m each side)	-	-	2 NO in	Latch	-	RP-QM90F-100L

## Components for Wire Rope Assembly

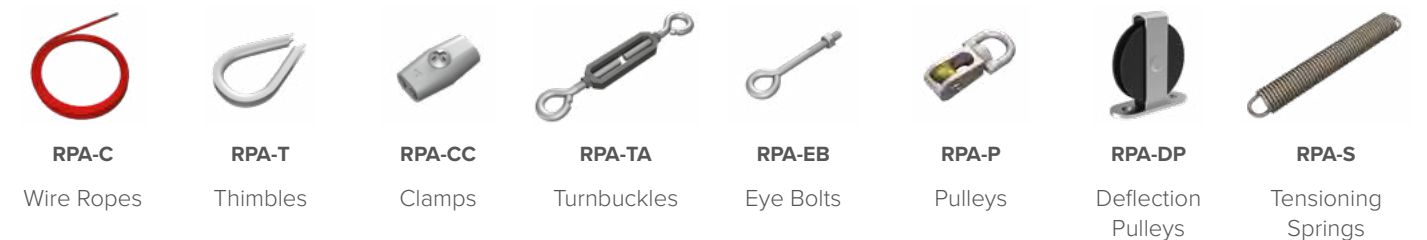

Hardware kits are available (RPAK)



# Smarter Automation. Better Solutions.™

Banner Engineering designs and manufactures industrial automation products including sensors, smart IIoT and industrial wireless technologies, LED lights and indicators, measurement devices, machine safety equipment, as well as barcode scanners and machine vision. These solutions help make many of the things we use every day, from food and medicine to cars and electronics. A high-quality, reliable Banner product is installed somewhere around the world every two seconds. Headquartered in Minneapolis since 1966, Banner is an industry leader with more than 10,000 products, operations on five continents, and a worldwide team of more than 5,500 employees and partners. Our dedication to innovation and personable service makes Banner a trusted source of smart automation technologies to customers around the globe.

