

OPTIMIZING COMFORT: THE ULTIMATE HVAC COMPONENT GUIDE

Take the heat off your search and explore HVAC component solutions.



HEAT YOUR HOME WITH CONFIDENCE

Heating your home during colder seasons is not just about comfort—it’s a vital necessity. With furnaces and heat pumps emerging as popular choices, understanding their differences is paramount. Furnaces, whether powered by gas or electricity, vary in operation based on their fuel source. However, in today’s world, the focus extends beyond mere warmth.

Governments worldwide are spearheading initiatives to combat climate change by promoting energy-efficient HVAC systems like heat pumps. Through tax incentives and subsidies, homeowners are encouraged to make environmentally conscious choices. Whether you opt for a furnace or a heat pump, the emphasis is on staying warm while minimizing your carbon footprint.

In this guide, we’ll navigate the intricacies of heating systems, explore the benefits of each option and provide insights to help you make informed decisions. Join us as we embark on a journey towards sustainable, eco-friendly home heating solutions.



Governments worldwide anticipate to implement strict regulations mandating the integration of heat pumps, which will have a positive effect on the market.

Government incentives in North America and Europe drive the shift towards green energy solutions, with mandatory CO2 emission regulations slowing boiler and furnace sales while boosting heat pump usage.

Recent advancements in heat pump technology have significantly improved efficiency, with specialized “cold climate” units now capable of extracting heat from air as cold as -30°C to efficiently warm homes.

The “Clean Heating Plan” in China aims to shift households from coal to cleaner heating alternatives, aligning with the country’s goal of carbon neutrality by 2060.

[Source: Markets & Markets Mordor intelligence](#)

HEAT PUMP BENEFITS



Energy Efficient



Environmentally Friendly



Cost Savings



Convenience

DESIGNING FOR THE ELEMENTS: SOLUTIONS FOR OUTDOOR HVAC SYSTEMS

As the residential HVAC market grows, there is an increasing demand for innovative technology that empowers engineers to develop HVAC systems with ingress protection (IP) rated sealed and space-saving components. This expansion reflects the evolving needs of homeowners for more efficient and resilient heating solutions. Consequently, there's a pressing need for HVAC component solutions that not only meet these demands but also pave the way for enhanced performance and longevity in home heating systems. TE Connectivity (TE) offers a comprehensive range of solutions engineered for environmental sealing, space-saving design, reliability, error-reducing assembly, and high vibration resistance, helping your HVAC equipment to operate more efficiently even in challenging conditions.

NAVIGATING HVAC DESIGN CHALLENGES



HARSH ENVIRONMENT



SERVICE & REPAIR



SEALING
CONTAMINATION



HVAC ASSEMBLY

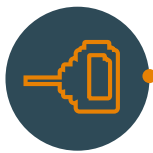

FAN MOTOR

- Relays
- Sensors
- Terminal & Splices
- Power Connectors
- Signal Connectors
- Heat Shrink Tubing
- Magnet Wire Solutions

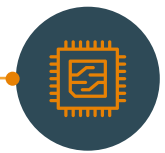

CONTROL SYSTEM

- Antennas
- Relays
- Sensors
- Terminal Blocks
- Terminal & Splices
- Power Connectors
- Signal Connectors
- Heat Shrink Tubing



COMPRESSOR

- Relays
- Sensors
- Terminal & Splices
- Power Connectors
- Signal Connectors
- Heat Shrink Tubing
- Magnet Wire Solutions



VALVES / SOLENOIDS

- Relays
- Sensors
- Signal Connectors
- Terminal & Splices
- Heat Shrink Tubing
- Magnet Wire Solutions



SENSING

- Sensors
- Power Connectors
- Signal Connectors
- Heat Shrink Tubing

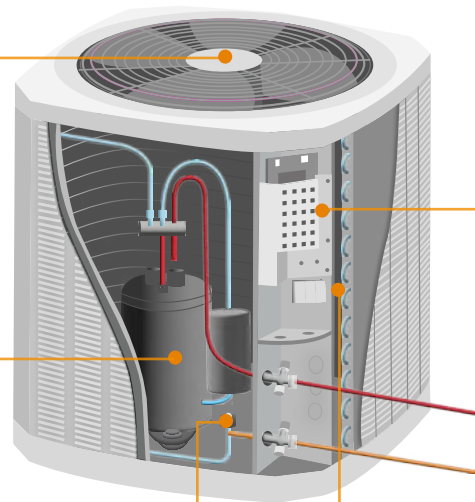



CHILL OUT AND EXPLORE HVAC COMPONENT SOLUTIONS

Global HVAC trends are all about efficiency and innovation. High-efficiency models like heat pumps and mini-splits are in the spotlight, offering energy savings and versatility. Market trends are moving towards smart technology like remote monitoring and energy management, while zoned cooling solutions provide personalized comfort. Heat pumps also tap into renewable energy sources like solar power for a greener future. Traditional air conditioning units still have their place, but the cool kids on the block are heat pumps and mini split units, leading the charge toward a more efficient and sustainable cooling landscape.



MINI SPLIT

	Easier and cheaper installation
	Much more efficient thanks to ductless system and individual zone control
	Comes in different versions to suit installation location
	Individual temperature settings per room

Ductless mini-split systems, equipped with advanced features, boost energy efficiency by controlling temperature, humidity, and fresh air intake. With growing investments in smart home tech, the ductless mini-split market is set to expand.



CENTRAL AIR

Requires Ducts	
Less efficient due to duct losses and single temperature	
Can only be installed in rooms with ductwork	
Single thermostat for the entire home	

Air conditioning manufacturers innovate to comply with stricter efficiency standards mandated by regulations and phase out environmentally harmful materials or substances, such as transitioning from R-22 to R-410 refrigerant.



TRANSFORMING INDOOR SPACES: CUTTING-EDGE COMPONENT SOLUTIONS

In the home cooling sector, the HVAC heat pump and air conditioning market is rapidly evolving, driven by key trends such as energy efficiency and the rise of smart HVAC technologies. TE Connectivity (TE) offers a range of compact yet powerful component solutions to elevate and refine HVAC designs. From high-efficiency connectors to intelligent sensors, TE empowers engineers to create innovative, energy-efficient cooling systems tailored to address the demands of modern homeowners.

OVERCOMING HVAC DESIGN CHALLENGES



SPACE
CONSTRAINTS



ENVIRONMENTAL
IMPACT



SEALING
CONTAMINATION



TEMPERATURE
ZONING



FAN MOTOR

- Relays
- Sensors
- Terminal Blocks
- Terminal & Splices
- Power Connectors
- Signal Connectors
- Heat Shrink Tubing
- Magnet Wire Solutions

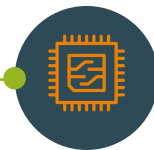
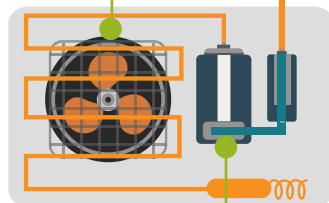

CONTROL SYSTEM

- Antennas
- Relays
- Sensors
- Signal Connectors
- Power Connectors
- Terminal Blocks
- Terminal & Splices
- Heat Shrink Tubing



COMPRESSOR

- Relay
- Sensors
- Terminal & Splices
- Power Connector
- Signal Connector
- Heat Shrink Tubing
- Magnet Wire Solutions



SENSING

- Sensors
- Signal Connectors
- Heat Shrink Tubing

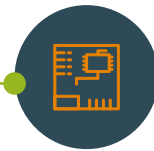

USER INTERFACE

- Antennas
- Signal Connectors
- Terminal & Splices
- Heat Shrink Tubing

ANTENNAS

TERMINAL BLOCKS

LOW POWER SIGNAL CONNECTS

QUICK CONNECTS

MAGNET WIRE SOLUTIONS

HVAC COMPONENT SOLUTIONS

SENSORS

HEAT SHRINK TUBING

RAST CONNECTS

POWER CONNECTS

RELAYS

MID POWER SIGNAL CONNECTS

ONLINE RESOURCES

RELIABLE COMPONENTS, YEAR-ROUND COMFORT

LANDING PAGE

SOLDERLESS MAGNET WIRE SOLUTIONS FOR HEAT PUMP COMPRESSORS

CASE STUDY

HEAT PUMP YOUR WAY TO EFFICIENT COMFORT

VIDEO

Engineering solutions begin here, connect now!

CONTACT US

ANTENNA SOLUTIONS

TE's antennas support cutting-edge HVAC systems with a wide range of wireless design options, from compact board mount solutions to large infrastructure antennas. Tailored frequencies, including 433-434 MHz, ISM, LoRaWAN/LPWAN, and NB-IoT, help provide communication and reliable data transmission. Our portfolio covers indoor monitoring and outdoor infrastructure needs, offering both internal and external antenna types. Engineered for optimal efficiency, TE antennas help ensure uninterrupted communication and data transmission for your HVAC systems. TE's antennas adapt to evolving technology standards, ensuring longevity and sustainability. Elevate your HVAC system with unmatched connectivity, reliability, and performance—explore TE's antenna solutions today.

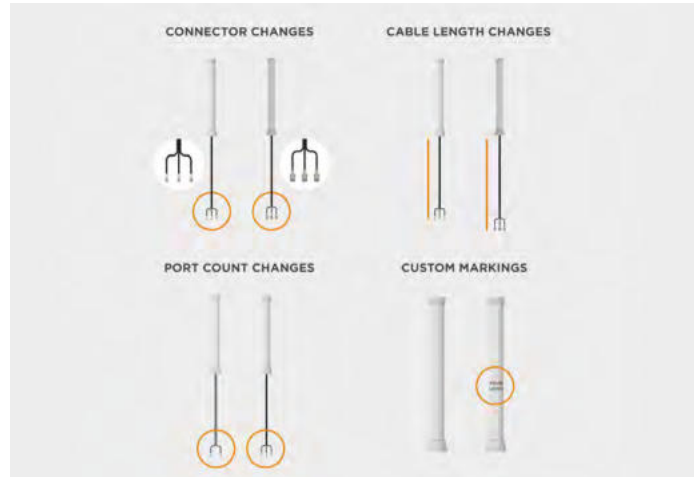





	Subsystems	Outdoor Unit Heat Pump or Air Conditioning Unit	Indoor Unit Mini-Split Unit
	Control System	YES	YES
	Motors/Compressors	NO	NO
	Valves/Solenoids	NO	
	User Interface		YES
	Sensing	NO	NO

	Product	Product Type	Application	Advantage
	410-470 MHz Internal Antennas	Internal/Embedded Antennas	Control Systems User Interfaces	<ul style="list-style-type: none"> Explore a diverse range of internal antennas customized for 433-434 MHz applications Choose from soldered board mount solutions or FPC antennas tailored to your requirements
	410-470 MHz External Antennas	External Antennas	Control Systems User Interfaces	<ul style="list-style-type: none"> Wide range of external antennas tailored for 433-434 MHz applications Options include indoor-only solutions and weatherproof, IP-rated outdoor antennas
	868 MHz Internal Antennas	Internal/Embedded Antennas	Control Systems User Interfaces	<ul style="list-style-type: none"> Diverse selection of internal antennas optimized for 868 MHz applications Options include soldered board mount solutions or FPC antennas
	868 MHz External Antennas	External Antennas	Control Systems User Interfaces	<ul style="list-style-type: none"> Array of external antennas customized for 868 MHz applications Options range from indoor-only solutions to weatherproof, IP-rated outdoor antennas
	902-930 MHz Internal Antennas	Internal/Embedded Antennas	Control Systems User Interfaces	<ul style="list-style-type: none"> Diverse array of internal antennas optimized for 902-930 MHz applications Options include soldered board mount solutions or FPC antennas
	902-930 MHz External Antennas	External Antennas	Control Systems User Interfaces	<ul style="list-style-type: none"> Diverse selection of external antennas tailored for 902-930 MHz applications Options include indoor-only solutions or weatherproof, IP-rated outdoor antennas
	Custom Antennas	Antennas	Control Systems User Interfaces	<ul style="list-style-type: none"> Complete the custom antenna request form today to learn how our experts can assist you.

HEAT SHRINK TUBING

When it comes to wire management, additional insulation, or protection in challenging environments, heat shrink tubing emerges as the ultimate solution for the HVAC market. Its versatility and reliability make it essential across a wide array of applications within HVAC systems. Whether you're looking to shield wires from abrasion, ward off moisture infiltration, or insulate components amidst extreme conditions, Raychem brand heat shrink tubing delivers unmatched performance. Count on it to provide that crucial extra layer of protection, enhancing both the durability and reliability of your HVAC systems. Partnering with TE for all your heat shrink tubing needs ensures peace of mind, as your equipment is fortified against the challenges of demanding environments, providing optimal functionality and longevity.



	Subsystems	Outdoor Unit Heat Pump or Air Conditioning Unit	Indoor Unit Mini-Split Unit
	Control System	YES	YES
	Motors/Compressors	YES	YES
	Valves/Solenoids	YES	
	User Interface		YES
	Sensing	YES	YES

	Product	ID	Shrink	Rating	Advantage
	SWFR X2 Single Wall Heat Shrink	1.0mm to 30.0mm (0.039in to 1.181in)	2:1	UL 224/ CSA VW-1	<ul style="list-style-type: none"> • Low shrink temperature enables swift installation • Environmentally friendly tubing emits minimal toxic or acidic gases during combustion, without added halogens • Single wire 600V rating helps ensure reliable electrical insulation • UL 224/CSA VW-1 flame rating enhances safety
	SWFR X4 Single Wall Heat Shrink	0.8mm to 25.0mm (0.032in to 0.984in)	2:1	UL 224/ CSA VW-1	<ul style="list-style-type: none"> • Thin wall and low shrink temperature enable fast installation and space-saving • Environmentally friendly material emits minimal toxic or acidic gases during combustion, without added halogens • Single Wire 300V rating helps ensure reliable performance • UL 224/CSA VW-1 flame rating enhances safety
	ATUM Tubing	3:1 ratio: 3.0mm to 40.0mm (0.118in to 1.570in) 4:1 ratio: 4.0mm to 52.0mm (0.158in to 2.050in)	3:1 & 4:1	ASTM D2671, Proc. B (Black only)	<ul style="list-style-type: none"> • Versatile high-shrink-ratio, adhesive-lined polyolefin tubing with 3:1 and 4:1 shrink ratios • Excelling in connector-to-cable sealing • Medium wall helps provide enhanced mechanical protection • ATUM adhesive helps ensure strong bonds with various materials • Reliable performance and durable connections
	RW-175	1.2mm to 50.8mm (0.046in to 2.000in)	2:1	ASTM D2671, Proc. C; UL 224/ CSA VW-1. Halogenated	<ul style="list-style-type: none"> • Tough, semirigid insulation with ultra-thin wall design • Highly flame-resistant and high-temperature performance for excellent durability • Resists solvents, fuels, and chemicals for reliable protection in diverse environments

HEAT SHRINK TUBING

HEAT SHRINK MACHINES AND EQUIPMENT

Our heat shrink equipment excels in sealing and protecting electrical splices while offering mechanical protection for fluid management systems, even in the harshest environments. With a focus on versatility and reliability, our machines deliver precise heating temperatures, excellent performance, and advanced control features, ensuring maximum efficiency across diverse applications. Explore our comprehensive portfolio below and connect with us for expert guidance and personalized equipment recommendations tailored to your specific needs.

[LEARN MORE ▶](#)



SEALED PROTECTION WHEN YOU NEED IT MOST



**INGRESS
PROTECTION (IP)
RATED**



**LOCKING /
COUPLING
METHODS**







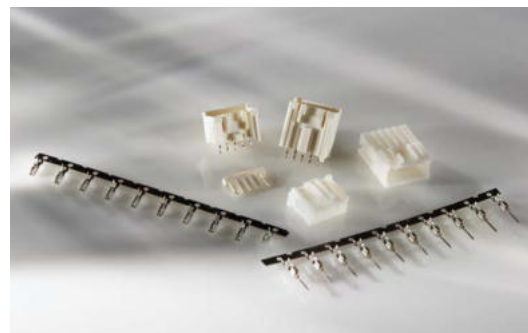

**ENVIRONMENTAL
SEALING**

When it comes to sealed protection TE Connectivity offers rugged connectors and high-performance heat shrink tubing built for harsh environments involving exposure to moisture, dust, debris, shock, and vibration. Engineers need to design for safety and durability while meeting global industry safety standards. At TE, we provide connectivity solutions that can meet complex application needs with a single connection.





LOW POWER SIGNAL CONNECTS

Introducing our low power signal connectors, the ideal solution for HVAC systems requiring reliable wire-to-wire or wire-to-board connections for signal or low-power applications. Engineered for high density within limited space constraints, these connectors meet stringent UL 94 V0 and IEC Glow Wire requirements, supporting safety and reliability. Commonly utilized in various HVAC components such as sensing, data transmission, displays, user interfaces, and powering small motors and actuators, TE's small but mighty connectors offer design flexibility, sealing and error minimizing assembly in HVAC applications.



	Subsystems	Outdoor Unit Heat Pump or Air Conditioning Unit	Indoor Unit Mini-Split Unit
	Control System	YES	YES
	Motors/Compressors	YES	YES
	Valves/Solenoids	YES	
	User Interface		YES
	Sensing	YES	YES

	Product	Pitch	AWG	Positions	Ratings	Advantage
	FFC/FPC and Ribbon Connectors	0.25 - 1.25	-	3-60	1.0 AMP, 50 VAC	<ul style="list-style-type: none"> Address market demand for miniaturization with smaller centerline spacing, lower profile heights, and lighter weights Actuator helps ensure secure cable termination Field terminatable for convenience Available in various centerline spacings from 0.25mm to 1.25mm for versatility
	AMP-Latch Ribbon Cable	0.64-1.27mm	20-32	10-60	1.0 AMP, 500-1,000 V	<ul style="list-style-type: none"> AMP-LATCH ribbon cable interconnects offer quick and reliable connections without wire stripping Ideal for transitioning between ribbon cable and PCB circuitry Provides secure and economical options for connecting boards or subsystems Helps ensure gas-tight connection for enhanced performance
	2.0mm Signal GRACE INERTIA Connectors	2.0mm	28-18	2-10 & 20	2.5 AMP, 50 VAC	<ul style="list-style-type: none"> Designed to enhance manufacturing efficiency Error-prevention features for seamless connections Supports automated processes Available in crimp or IDC options for high-volume assembly Offers right angle or vertical
	GRACE INERTIA 2.5mm Connectors	2.5mm	28-22	2-12	3.0 AMP, 50 VAC	<ul style="list-style-type: none"> Safeguards against half-mating and back-out issues Designed for high-volume manufacturing Suitable for wire-to-board and wire-to-wire applications Inertia lock mechanism helps ensure secure connections Emphasizes stability, durability, and ease of assembly
	2.5mm Signal Double Lock Connectors	2.5mm	26-20	2-14	3.0 AMP, 250 VAC/ VDC	<ul style="list-style-type: none"> Reliable and easy assembly in tough environments Compact double lock plate helps ensure secure contact seating IP67 sealing for enhanced dust and water protection Available in standard and high-profile versions

	Product	Pitch	AWG	Positions	Ratings	Advantage
	Economy Power 2.5 Connectors	2.5mm	26-20	2-40	4.2 Amps, 250 VAC	<ul style="list-style-type: none"> Designed for easy retrofit with similar 2.5 pitch connectors Ideal for tight spaces in limited low power and signal systems Features polarization tabs to prevent post misalignment Audible positive latching helps ensure complete mating Low insertion force (LIF) contacts enable ergonomic assembly
	Micro MATE-N-LOK Connectors	3.0mm	30-18	2-24	5.0 AMP, 250 VAC	<ul style="list-style-type: none"> Low profile board mounting height (<4.7mm) Pick and place capable Positive latching mechanism to prevent unmating Various optional features: contact
	ERNI MicroCon connector	0.8mm	34	16, 26, 40, 50 pin	up to 2.3 A / pin @ 20°C	<ul style="list-style-type: none"> Miniaturization is key – pitch of 0.8 mm Dual-beam female contact and low contact resistance for high reliability, current carrying capacity of up to 2.3 A / pin at 20°C SMT technology, solder clips for robustness and locating pegs for precise positioning on pcb Available pin-count: 12 – 100; Unmated stacking height male: up to 10 mm; Unmated stacking height female: up to 8 mm
	ERNI SMC connector	1.27mm	30	12 until 80 pin	up to 1.7 A / pin @20°C	<ul style="list-style-type: none"> Design flexibility due to the availability of board-to-board, board-to-wire and board-on-IDC variants, combination of short connector length and high pin-count at the same time High reliability given by solder clips and polarization, different contact technologies: SMT, pressfit and IDC High contact reliability by using dual-beam female contact and Au-plating Large number of configurations available with different stacking heights (8-40mm), different pin-count (12-80 pin) and different cables types



HVAC SEALED SOLUTIONS

SEALED CONNECTORS IN HARSH ENVIRONMENTS



WATCH NOW ▶

LOW POWER SIGNAL CONNECTS

CERTI-CRIMP PREMIUM HAND TOOLS

Explore our range of Premium CERTI-CRIMP hand tools, meticulously crafted to crimp a diverse selection of terminals, contacts, and special wiring devices from TE. Engineered to exacting specifications, these tools can help ensure consistent, high-quality terminations. With potential service life exceeding 50,000 cycles, depending on operator care, they offer durability and reliability. Choose from seven basic styles of CERTI-CRIMP hand tools, each tailored to the specific application, helping ensure precise and efficient crimping.

[LEARN MORE ▶](#)



SDE CRIMP COMMERCIAL TOOLS

Introducing our revolutionary SDE Crimp commercial tool system, combining the pioneering features of our original PRO-CRIMPER hand tools with enhanced versatility and robustness. Featuring Standard Die Envelope (SDE) die sets, SDE Crimp minimizes the need for multiple hand tools by offering easily interchangeable sets for both manual and power-assisted operations. The enhanced tool frame ensures greater operator comfort, efficiency, and crimping quality. Available as a fully assembled tool or with the frame and die set sold separately, SDE Crimp can offer unmatched flexibility and performance in crimping.

[LEARN MORE ▶](#)



BENCHTOP WIRE CRIMPING MACHINES

Explore our extensive line of bench-top wire crimping machines designed for low to medium volume wire processing. From the advanced Model G II+ to the economical AMP 3K and 5K Terminators, our machines offer flexibility, performance, and reliability. The AMP-O-LECTRIC Model G II terminator with thru-splice applicator streamlines thru-splice application for maximum production efficiency.



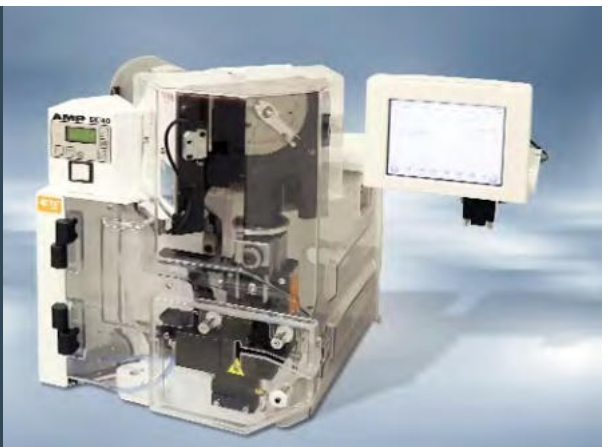

[LEARN MORE ▶](#)



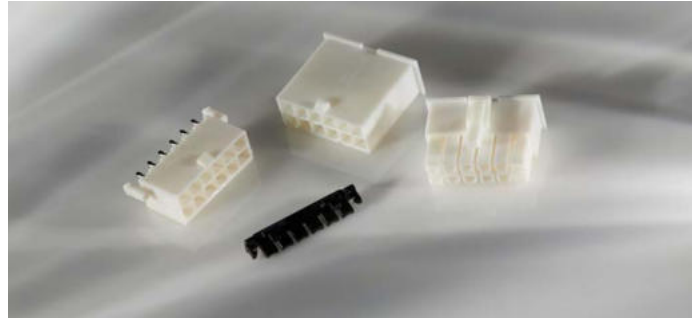





MID POWER SIGNAL CONNECTS

Presenting our mid power signal connect solutions, tailored for signal or low-power wire-to-wire or wire-to-board connections in HVAC and mid-power applications. These robust connectors provide high density within limited space, can withstand high vibrations and meet rigorous UL 94 V0 and IEC Glow Wire requirements. They are commonly utilized for control systems, HVAC fan motors and compressors.



	Subsystems	Outdoor Unit Heat Pump or Air Conditioning Unit	Indoor Unit Mini-Split Unit
	Control System	YES	YES
	Motors/Compressors	YES	NO
	Valves/Solenoids	NO	
	User Interface		NO
	Sensing	NO	NO

	Product	Pitch	AWG	Positions	Ratings	Advantage
	Economy Power Connectors	3.96mm	22-18	1-11	8.0 Amps, 250 Volts	<ul style="list-style-type: none"> End-to-end stackable and intermateable with similar competitive products for retrofit applications Polarization feature helps prevent plug mating with misalignment Wire-to-board connectors for compact power systems with large current carrying capacity
	Economy Power II Connectors	3.96mm	22-16	1-12	11 AMP, 600 Volts	<ul style="list-style-type: none"> End-to-end stackable and intermateable with similar competitive products for retrofit applications Asymmetrical terminals helps prevent mis-mating Polarization feature helps prevent plug mating with misalignment Terminal position assurance (TPA) available for EP II model
	Power Double Lock Connectors	3.96mm	26-16	1-12	14.0 Amps, 300 Volts	<ul style="list-style-type: none"> High force contacts designed for high vibration environments Secondary locking 14A power connectors Double locking plate helps prevent partial mating of contacts Lance-less contacts help prevent tangled wires, semi-inner locking system helps prevent disengagement, PCB header solder tail for secure soldering Wire-to-board headers designed to support conformal coating waterproofing
	VAL-U-LOK Connectors	4.20mm	26-16	2-24	13.0 Amps, 600 Volts	<ul style="list-style-type: none"> Wire-to-wire and wire-to-board connections with contacts on a 4.20mm centerline and high current capacity of up to 13A per line VAL-U-LOK PLUS connectors (2-6 position) streamline sourcing and assembly processes for wire harness and PCB manufacturers Robust single latch and anti-snagging feature helps prevent wire entanglement Meets UL 94 V-0 and IEC 60335-1 glow wire test (GWT) flammability standards
	MTA 156 Connectors	3.96mm	26-18	2-24	7.0 Amps, 600 Volts	<ul style="list-style-type: none"> IDC contact helps ensure easy assembly End-to-end stackable design and helps prevent reverse mating Fretting corrosion protection for enhanced durability One-step assembly with no wire stripping or contact damage Reduces wiring errors and simplifies tooling requirements
	GRACE INERTIA 6.5 Connectors	6.5mm	24-16	3	9.0 Amps, 300 Volts	<ul style="list-style-type: none"> Capable of withstanding Glow Wire testing Features an inertia locking mechanism

MID POWER SIGNAL CONNECTS

CERTI-CRIMP PREMIUM HAND TOOLS

Premium CERTI-CRIMP hand tools crimp a wide range of terminals, contacts, and special wiring devices from TE to exacting specifications, helping ensure consistent, high-quality terminations. With a potential service life of over 50,000 cycles, depending on operator care, there are seven basic styles available to suit various applications.

[LEARN MORE ▶](#)



SDE CRIMP COMMERCIAL TOOLS

Our SDE Crimp commercial tool system combines pioneering features of our original PRO-CRIMPER hand tools with enhanced versatility and robustness. SDE Crimp reduces the need for multiple hand tools with its easily interchangeable Standard Die Envelope (SDE) die sets, accommodating both manual and power-assisted operations. The enhanced tool frame helps ensure greater operator comfort, efficiency, and crimping quality. Available as a fully assembled tool or with the frame and die set sold separately (PN 2362810-1), SDE Crimp offers unmatched flexibility and performance in crimping.

[LEARN MORE ▶](#)



MASS TERMINATION ASSEMBLY CRIMP TOOLING

Tailored for PCB headers, mass termination connectors pre-loaded with contacts, crimp-snap contacts and housings, as well as card edge connectors with pre-loaded contacts, TE's MTA tooling helps ensure reliable and efficient crimping. Our interchangeable crimp heads provide flexibility, allowing seamless transition from manual tools (50-100 crimps per day) to power-assisted bench units (200+ crimps per day) based on your production volume needs.

[LEARN MORE ▶](#)



BENCHTOP WIRE CRIMPING MACHINES

TE's bench-top wire crimping machines offer flexibility, performance, and reliability for low to medium volume wire processing. Featuring advanced designs, the Model G II+ and AMP 3K/5K terminators help ensure efficient wire termination. The AMP-O-LECTRIC Model G II terminator with thru-splice applicator enhances production efficiency by facilitating thru-splice application.



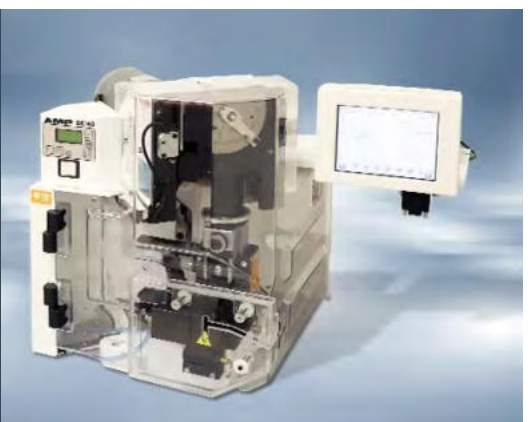

[LEARN MORE ▶](#)

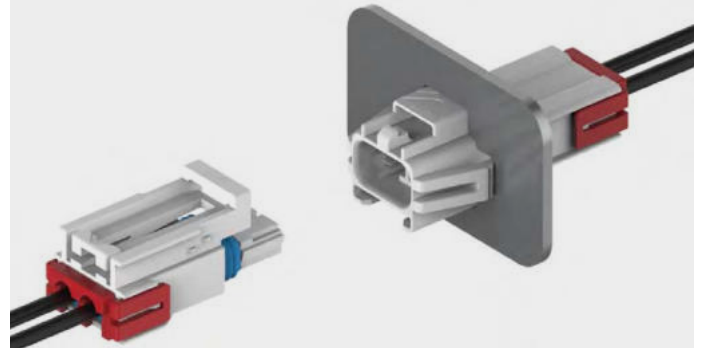

POWER CONNECTS

Our power connect solutions are designed for applications requiring up to 20 Amps of power, offering versatility to serve as signal connections with a larger pitch as well. These connections adhere to stringent UL 94 V0 and IEC Glow Wire requirements, helping ensure safety and reliability. Typical applications encompass powering motors, main power supplies, lighting systems, and providing power to high-power electronics, catering to diverse needs within HVAC systems.



	Subsystems	Outdoor Unit Heat Pump or Air Conditioning Unit	Indoor Unit Mini-Split Unit
	Control System	YES	YES
	Motors/Compressors	YES	YES
	Valves/Solenoids	NO	
	User Interface		NO
	Sensing	NO	NO

	Product	Pitch	AWG	Positions	Ratings	Advantage
	Universal MATE-N-LOK Connectors	6.35mm	30-10	1-15 2-15 (II)	19 Amps, 600 Volts	<ul style="list-style-type: none"> Cap and plug housings enable mixing of pin and socket contacts within the same housing for enhanced flexibility Splash-proof sealed version Terminal position assurance (TPA) for 2-5 positions
	POWER TRIPLE LOCK Connectors	6.0mm	12-20 2x18 2x20	2-15	20 Amps, 600 Volts	<ul style="list-style-type: none"> Lowest mating force, simple locking, with TPA's and connector position assurance (CPA) Available in single, double, and triple row configurations High temperature rating of 150°C, with GWT options Color-coded keying for easy identification
	Power Versa-Lock Connectors	5.0mm	26-14 2x22	1-4, 6, 9	15 Amps, 600 Volts	<ul style="list-style-type: none"> IP67 rated when used with optional seals Maximum temperature of 130°C Terminal position assurance (TPA) and Glow Wire Testing (GWT) options available Color-coded keying for easy identification
	ERNI PowerTaps	2.54mm	-	6, 10 pin	20°C 40 A, 70°C 24A, 100°C 8 A	<ul style="list-style-type: none"> Easy wire-to-board combination with high current carrying capacity of up to 40A @ 20°C* Different variants in the portfolio to adapt to different design needs of customers, different screw types offered 6 and 10 pin available Pressfit and solder technology available

*The operating current is determined by characteristics of the pcb and the cable termination

POWER CONNECTS

CERTI-CRIMP PREMIUM HAND TOOLS

Experience the precision and reliability of our Premium CERTI-CRIMP hand tools, meticulously engineered to crimp a diverse range of terminals, contacts, and special wiring devices from TE. Crafted to exacting specifications, these tools help ensure consistent, high-quality terminations with a potential service life of over 50,000 cycles, contingent upon operator care. With seven basic styles of CERTI-CRIMP hand tools available, the optimal choice depends on the specific requirements of the product being applied

[LEARN MORE ▶](#)



SDE CRIMP COMMERCIAL TOOLS

Our SDE Crimp commercial tool system combines pioneering features of our original PRO-CRIMPER hand tools with enhanced versatility and robustness. With interchangeable Standard Die Envelope (SDE) die sets, it seamlessly transitions from manual to power-assisted tools. The improved tool frame helps ensure operator comfort, efficiency, and crimping quality. Available fully assembled or with the frame and die set sold separately (PN 2362810-1), SDE Crimp offers unmatched flexibility and performance.

[LEARN MORE ▶](#)



BUILT TO TAME VIBRATION CHAOS



LOCKING / COUPLING METHODS

Select the appropriate locking coupling mechanism to ensure connector durability in harsh environments.







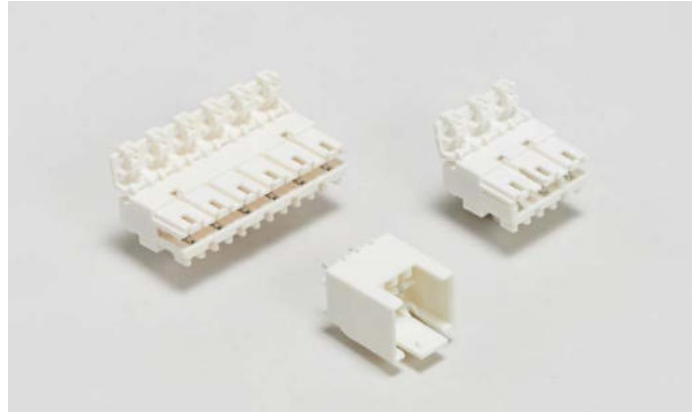

TERMINAL POSITION ASSURANCE

An inexpensive way to prevent costly rework is by assuring the terminals are fully seated and cannot backout.

RAST CONNECTIONS

RAST connectors offer an ideal solution for high-volume assembly, particularly in HVAC systems, although an initial investment in tooling is required. Their standardized design allows interoperability among manufacturers adhering to the RAST standard, ensuring seamless integration into HVAC equipment. Keying and polarization features help ensure error-proof connections, even with multiple connectors of the same size, enhancing reliability and safety in HVAC applications. With a comprehensive portfolio covering both signal and power connectors, RAST connectors provide versatility for various HVAC system components, facilitating efficient assembly and operation.







	Subsystems	Outdoor Unit Heat Pump or Air Conditioning Unit	Indoor Unit Mini-Split Unit
	Control System	YES	YES
	Motors/Compressors	YES	YES
	Valves/Solenoids	YES	
	User Interface		YES
	Sensing	YES	YES





	Product	Pitch	AWG	Positions	Ratings	Advantage
	AMP DUOPLUG Mark II Connectors	2.5mm	24-22	2-20	2.0 Amps, 250 V	<ul style="list-style-type: none"> • IDC (Insulation displacement contacts) Connectors that support high-volume wire termination without stripping and crimping • Connector mates with PCBs directly or indirectly via headers connectors • Offers different keying options with GW V0/V2 flammability • Covered with UL and VDE agency approvals
	Monoplug 2.5 Connectors	2.5mm	24-22	2-13	2.0 Amps, 250 V	
	Monoplug Power Connector	2.5mm	22-18.5	2-7	9.0 Amps, 250 V	
	AMP DUOPLUG Power Connectors	5.0mm	22-18	2-9	6 AMPs, 250 V	
	Positive Lock RAST 5 Connector System	5.0mm	22-14	2-11	16.0 Amps, 500 V	• Crimp solution, larger wire size
	RAST 5 Standard Timer Connectors	5.0mm	22-12	2-12	16.0 Amps, 220 V	• Crimp solution, larger wire size
	AMP Multifitting Mark II Connectors	5.0mm	22-15.5	1-10	16.0 Amps, 250 V	• IDC termination, high productivity
	AMP MONO-SHAPE Connectors	5.0mm	20-15.5	1-12	16.0 Amps, 380 V	• IDC termination, high productivity

MAGNET WIRE SOLUTIONS

Our magnet wire solutions provide a convenient alternative to manual soldering or welding, eliminating the need to remove insulation. They're excellent for connecting magnet wire to magnet wire and/or stranded wire. In compressors, maintaining a seal between the motor and the external power supply is vital. Our electrical pass-through cluster block connector system helps ensure this seal, offering hermetic protection. Explore TE's solderless magnet wire solutions for enhanced performance in both internal and external connections to compressors.



	Subsystems	Outdoor Unit Heat Pump or Air Conditioning Unit	Indoor Unit Mini-Split Unit
	Control System	NO	NO
	Motors/Compressors	YES	YES
	Valves/Solenoids	YES	
	User Interface		NO
	Sensing	NO	NO

	Product	Cavity / Housing	Copper	Aluminum	CMA	Magnet Wire Range (mm)		Advantage
						Lead wire Range (AWG)	Fusite Pin Diameter (mm)	
	AMPLIVAR Terminals & Splices	No	-	-	100- 22,000	30-6.5	-	<ul style="list-style-type: none"> Terminals and splices boast a serrated barrel design, helping ensure superior metal-to-metal compression crimp joints with unmatched strength and reliability. New application tooling enables infinite combinations of bussed splices.
	MAG- MATE Terminals	Yes	0.02-2.05	0.18-2.30	-	26-14	-	<ul style="list-style-type: none"> IDC solution requires no pre-stripping, suitable for high-volume production and automation, handles multiple wires. Terminals feature insulation displacement contact (IDC) for gas-tight magnet wire termination. Standard MAG-MATE terminals support 34-12 AWG magnet wires, smaller versions for fine gauge wire. Available in various styles: poke-in, poke-in tab, splice, crimp wire barrel, solder post, and others
	SIAMEZE Terminals	Yes	0.13-2.05	0.40-2.30	-	22-16	-	<ul style="list-style-type: none"> IDC technology for a secure metal-to-metal interface without stripping magnet wire. Compact design ideal for space-constrained motor systems. Optional Lead Lok feature helps ensure high retention force for securing lead wires.
	Hermetic Cluster Blocks	Yes	-	-	200- 16,480	22-8	2.29/3.18	<ul style="list-style-type: none"> Insulated quick-connect solution for mating to hermetic header pins used as pass-through connectors in compressor systems. Available for interior and exterior compressor use, designed to withstand mechanical impact and exposure to oils and refrigerants. Cluster block terminals accommodate lead wire or magnet wire connections.

MAGNET WIRE SOLUTIONS

MAGNET WIRE EQUIPMENT

Our magnet wire termination machines are designed for terminating various products like magnet wire pigtail splices, coils, MAG-MATE splices and terminals. With a wide range of configurations available for MAG-MATE and AMPLIVAR splices and terminals, we help ensure high reliability with minimal wire preparation. Plus, many TE machines offer automatic precision adjustment functionality (CQM) for enhanced efficiency. Need help finding the right equipment? Click the “Find a Solution for Your Application” button below to get started.

[LEARN MORE ▶](#)

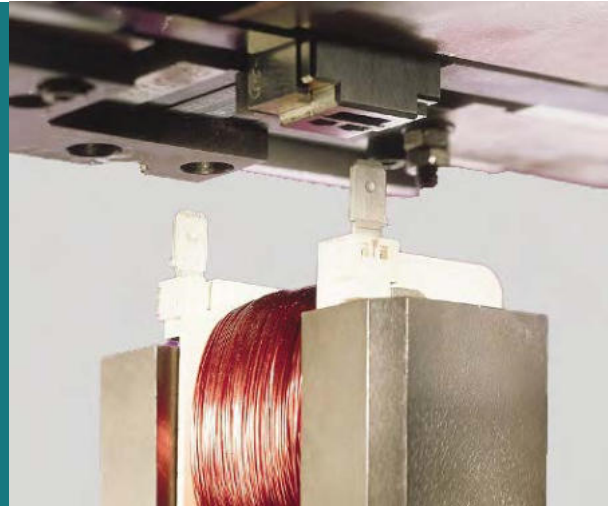

AMPLIVAR PRODUCT TERMINATOR

Our AMPLIVAR 5A and AMPLIVAR 5E terminators are designed for crimping magnet wire and pigtail AMPLIVAR splices (up to three wires in one splice) and direct connect AMPLIVAR contact terminals. Offering a fast and efficient system, these machines require no stripping of magnet wire insulation. Simply place the wires in the target area and depress the foot switch. The machine automatically shears the AMPLIVAR splice or AMPLIVAR direct connect contact from the strip, crimps it, shears off excess wire, and advances the next splice or contact into position.

[LEARN MORE ▶](#)



INVERTED AMPLIVAR SPLICE TERMINATORS AND APPLICATORS

The inverted splice termination (IST) terminator and applicator efficiently terminate pig-tail splices or thru-splices comprising two or more stranded or magnet wires. Capable of handling combinations with circular mil area (CMA) ranging from 400 to 13,000, when applied as per the corresponding terminal application specification. For applications beyond these specifications, kindly reach out to TE Application Tooling team for assistance.





[LEARN MORE ▶](#)









QUICK CONNECTS

Quick connects provide efficient solutions for discrete wire-to-wire and wire-to-board connections in HVAC systems. With standardized tab and receptacle designs, they allow easy component replacement in the field using standard tools or none at all. These connectors are primarily utilized for power applications such as connections to motors, capacitors, and contactors, ensuring reliable and convenient electrical connections in HVAC setups.



	Subsystems	Outdoor Unit Heat Pump or Air Conditioning Unit	Indoor Unit Mini-Split Unit
	Control System	YES	YES
	Motors/Compressors	YES	YES
	Valves/Solenoids	YES	
	User Interface		YES
	Sensing	NO	YES

	Product	Ergonomics	AWG	Ratings	Advantage
	FASTON Terminals	15-80N mating force	26-8	24 Amps, 110-250C	<ul style="list-style-type: none"> • Cost-effective and highly versatile option suitable for diverse applications. • Compatible for use with or without housings, including high-temperature variants. • Crimp Types: 2D crimp, F-crimp, C-crimp and Tab-lock
	Ultra-Fast FASTON Receptacles and Tabs	<75.6N mating force	26-10	24 Amps, 105C	<ul style="list-style-type: none"> • Offers excellent ergonomics with pre-insulated and color-coded design. • Compatible with D-crimp configuration for easy and efficient use. • Terminals are offered as straight receptacles, flag receptacles and tabs.
	Positive Lock Terminals	-30N per contact - varies by series	26-10	24 Amps, 125-250C	<ul style="list-style-type: none"> • Best ergonomics with a cam system enabling low mating force and high retention • High-temperature versions available for F- crimp and C-crimp configurations
	SOLISTRAND Terminals and splices	-	600MCM-26AWG	Based on wire size	<ul style="list-style-type: none"> • Spade, rings, tongues, and splices suitable for high performance and harsh environments • Specifically designed for large wire applications (O crimp)
	Ultra-Pod FASTON Pre-insulated Terminals	<80.1N mating force	22-10	24 Amps, 105C -125C	<ul style="list-style-type: none"> • LIF 125C version available with <36N mating force • Continuous strip on reel for convenient handling • Pre-insulated for ease of use • Compliant with Glow Wire and V0 standards • Suitable for high-temperature applications
	Open Barrel Ring Tongue	-	18-14	65 Amps, 110C	<ul style="list-style-type: none"> • Grounding solution with open barrel design • Terminal blocks featuring 2D/F crimp • Anti-rotational feature for secure connections • Stud retaining capability for added stability

QUICK CONNECTS

BENCHTOP WIRE CRIMPING MACHINES

Our bench-top wire crimping machines offer flexibility, performance, and reliability for low to medium volume wire processing. The Model G II+ and AMP 3K/5K terminators provide advanced solutions, while the AMP-O-LECTRIC Model G II Terminator with thru-splice applicator maximizes production efficiency.

[LEARN MORE ▶](#)

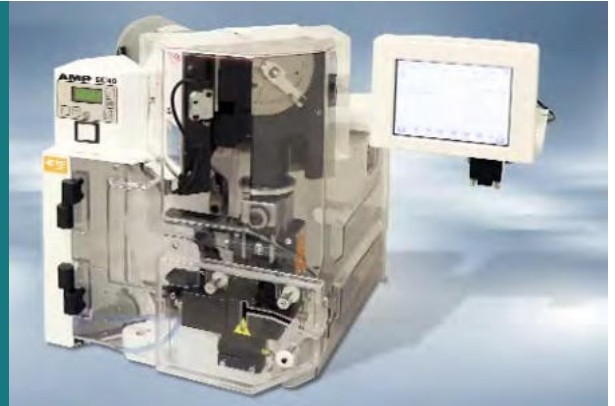

TETRA-CRIMP HAND TOOL

Our TETRA-CRIMP hand tool (part #59824-1) is designed to crimp a variety of PIDG and PLASTI-GRIP contacts and splices. Featuring fixed and movable dies, a locator/wire stop, and a ratchet mechanism, it helps ensure precise crimping and excellent electrical performance. Color-coded crimp nests match wire sizes for easy identification.

[LEARN MORE ▶](#)



**UNLOCK
EFFICIENCY:
FAST, FLEXIBLE
& MINIATURIZED
TERMINAL
SOLUTIONS**



PRE-INSULATED



CRIMP



STRAIGHT
ORIENTATION



FLAG
ORIENTATION



RELAYS

TE's power and signal relays can be crucial for HVAC systems, offering efficiency and control. Power PCB relays, used in thermostats, boilers, pumps, and fan control, provide reliability with inrush capabilities, extended lifespan, and wide temperature range. Signal Relays, essential for thermostat heating system switching, are compact and handle up to 5A. TE's power relays offer versatility with one and two-pole configurations, meeting various HVAC design needs. Signal relays provide space-saving solutions with low-profile versions, supporting smaller units. With UL approval for A2L safety, TE helps ensure compliance with eco-friendly HVAC equipment requirements.



	Subsystems	Outdoor Unit Heat Pump or Air Conditioning Unit	Indoor Unit Mini-Split Unit
	Control System	YES	YES
	Motors/Compressors	YES	YES
	Valves/Solenoids	YES	
	User Interface		NO
	Sensing	NO	NO

	Product	Contact Arrangement	Ratings	Advantage
	SCHRACK Power PCB Relay RZ	1 Form A (NO) 1 Form A (SPST-NO) 1 Form C (CO)	16A, 250 VAC	<ul style="list-style-type: none"> Versatile PCB relays ideal for various applications, blending power and sensitivity. Available in multiple contact and plating configurations to suit diverse needs. Capable of handling switching amperages of up to 16 Amperes, ensuring reliability and flexibility. UL 60335-2-40 A2L certified.
	SCHRACK Power PCB Relay RT	1 Form A (NO)	16A, 250 VAC	<ul style="list-style-type: none"> RT1 Power PCB Relay available in inrush, monostable, and bistable versions. Offers a standard 16 Amps global footprint for compatibility across applications. UL 60335-2-40 A2L certified.
	SCHRACK Miniature Power PCB Relay PB	1 Form A (NO) 1 Form C (CO)	6A, 10A	<ul style="list-style-type: none"> Environmentally-friendly cadmium-free contacts Class F coil system standard Compact and simple design gives high process security product in accordance to IEC 60335-1 UL 60335-2-40 A2L certified.
	ORWH	1 Form A (NO) 1 Form A (SPST-NO) 1 Form C (CO)	10A, 15A, 28 VDC, 250 VAC	<ul style="list-style-type: none"> Miniature PCB relay ORWH offers a compact design with 1 Form A and 1 Form C contact arrangement. Features a 10A switching capacity and is available in both flux-proof and sealed types. UL 60335-2-40 A2L certified.
	OJS Relay	-	10A, 16A	<ul style="list-style-type: none"> High performance power PCB relays (size compatible with existing OJ relay) Higher rated current, Small size and compact design saves space on board

RELAYS

	Product	Contact Arrangement	Ratings	Advantage
	Potter & Brumfield T9A Relay	1 Form A (NO) 1 Form B (NC) 1 Form C (CO)	NO 30A, 240VAC, NC 15A, 240VAC CO 20A/10A, 240VAC	<ul style="list-style-type: none"> T9A Power Relay offers an option for load connections via QC terminals. Standard 30 Amps global footprint enhances its versatility. APAC region preferred. UL 60335-2-40 A2L certified.
	Potter & Brumfield T92 Relay	2 Form A (NO) 2 Form C (CO)	NO 30A, 277VAC CO 30A/2A 277VAC	<ul style="list-style-type: none"> P&B T92 Series offers a two-pole 30A Panel Mount or PCB Power Relay. 40A UL rating available Designed to control compressor loads up to 3.5 tons, with 110LRA / 25.3FLA. UL 60335-2-40 A2L certified.
	Potter & Brumfield T9G Relay	1 Form A (NO) 1 Form B (NC) 1 Form C (CO)	NO 30A 277VAC NC 20A 250VAC CO 20A/10A 240VAC	<ul style="list-style-type: none"> T9G relay series: A compact 30 amp power PCB relay for HVAC, appliances, and industrial control. Offers a smaller footprint without compromising performance, allowing more components on PCBs. UL and VDE certifications ensure global compatibility. EMEA and AMER region preferred UL 60335-2-40 A2L certified.
	Axicom IM Signal Relays	1 Form A (NO) 1 Form C (CO) 2 Form A (NO) 2 Form C (2 CO)	2A 5A, 250 VAC, 220 VDC	<ul style="list-style-type: none"> Slimline, low-profile IM standard signal relay with high mechanical shock resistance. Supports up to 5A switching current. Low coil power consumption (<200mW) Available in both monostable or bistable versions Offered in a wide variety of terminal type UL 60335-2-40 A2L certified.
	Axicom P2 Signal Relays	2 Form A (NO) 2 Form C (2 CO) 2 Form C (CO)	2A, 250 VAC, 220 VDC	<ul style="list-style-type: none"> Small signal relay (slimline 15x7.5mm) with a switching current of 2A. Features 2 form C bifurcated contacts. High sensitivity for low power consumption (140mW/70mW) UL 60335-2-40 A2L certified.
	RYII Relay	SPDT / 1 FORM C / 1 C/O SPST-NO / 1 FORM A / 1 N/O SPST-NC / FORM B / 1N/C	8A, 250VAC	<ul style="list-style-type: none"> Low component height 12.3mm Plastic materials according to IEC 60335-1 Enclosed-break device approvals: IEC 60079-1 and UL121201 UL 60335-2-40 A2L certified.
	MSR Relay	SPDT / 1 FORM C / 1 C/O SPST-NO / 1 FORM A / 1 N/O	10A, 250VAC	<ul style="list-style-type: none"> High inrush currents with AgSnO2 contacts (TV4 0 65A) Ambient temperature up to 85°C at 8A Plastic materials according to IEC 60335-1 Enclosed-break device approvals: IEC 60079-1 and UL121201 UL 60335-2-40 A2L certified.

A2L UL RELAYS



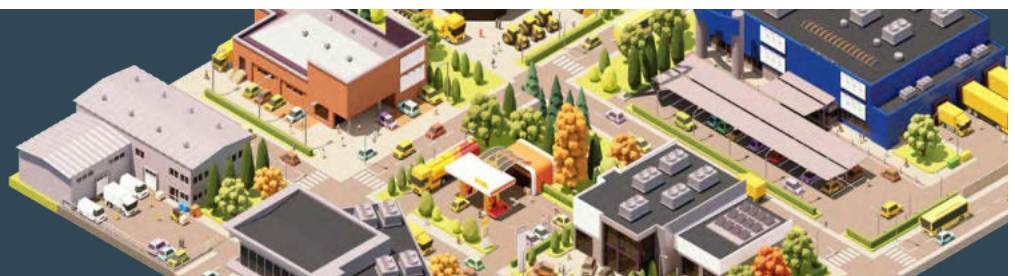

LEARN MORE ►





SENSORS

Sensors are an integral part of most heating, ventilation, air-conditioning, and refrigeration systems (HVAC) — helping to not only maintain a comfortable indoor climate but also to enable the system to perform properly. Sensors enable diagnostics that help identify system or equipment issues that could reduce efficiencies or cause major breakdowns to occur. Sensor technologies help reduce downtime, improve productivity, and lower maintenance costs. Within the last 30 years, there has been a push for HVAC systems with higher efficiencies and improved temperature control as well as the need to monitor and regulate other physical parameters like humidity, air quality and more. TE manufactures a wide range of rugged and reliable sensors for HVAC applications including pressure, temperature, humidity, vibration, position and force. These sensors play a critical role in improving the efficiency, performance and reliability of HVAC systems.







	Subsystems	Outdoor Unit Heat Pump or Air Conditioning Unit	Indoor Unit Mini-Split Unit
	Control System	YES	YES
	Motors/Compressors	YES	YES
	Valves/Solenoids	YES	
	User Interface		NO
	Sensing	YES	YES

	Product	Application	Sensor Part Numbers	Advantage
	Board Mount Pressure Sensors	<ul style="list-style-type: none"> VAV Controllers Filter Monitoring Fire Dampers Roof Vents Fire Suppression Pressure 	SM9000 Ultra Low Pressure	<ul style="list-style-type: none"> Lower pressure ranges Higher accuracy Superior stability
	Media Isolated/Pressure Transducers	<ul style="list-style-type: none"> Chiller Refrigerant Water System Pressure Monitoring 	U7100	<ul style="list-style-type: none"> Specifically designed for high volume applications Low pressure ranges Excellent durability
	Media Isolated/Pressure Transducers	<ul style="list-style-type: none"> Chiller Refrigerant Water System Pressure Monitoring 	M7100	<ul style="list-style-type: none"> Rugged design suitable for heavy equipment and outdoor use Resistant to high vibration Water resistant, capable of surviving immersion up to 1 meter



TERMINAL BLOCKS

TE's terminal blocks offer simpler installation, innovative technologies, various design options and different color coding for easier identification. Ease of assembly is facilitated by our built-in interlocks on the modular housing types. Pre-assembled products can be delivered upon request. Header housings are available in high-temperature resin for cost-efficient reflow soldering process.

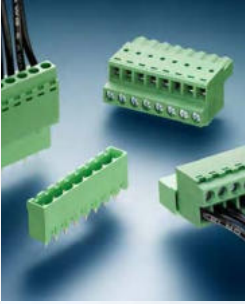

	Subsystems	Outdoor Unit Heat Pump or Air Conditioning Unit	Indoor Unit Mini-Split Unit
	Control System	YES	YES
	Motors/Compressors	NO	NO
	Valves/Solenoids	NO	
	User Interface		NO
	Sensing	NO	NO

	Product	Pitch	AWG	Positions	Ratings	Advantage
	BUCHANAN PCB Terminal Blocks	2.54 3.5 3.81 5 5.08 6.35 7.5 7.62 9.53 10 10.16 15	14 - 26 20 - 1 20 - 16 22 - 14 24 - 10 24 - 14 24 - 16 26 - 12 26 - 16 26 - 18 26 - 6 28 - 16 30 - 10 30 - 12 30 - 14 30 - 16	2-25	0.15, 2, 7, 8, 10, 11, 12, 13.5, 15, 16, 17.5, 24, 30, 65, 125, 130, 300A	Our large portfolio of BUCHANAN brand PCB terminal blocks have a range of wire termination methods, such as rising cage screw clamp and push-in clamp. PCB terminal block connectors are designed using one-piece board mount terminal blocks and two-piece plug connectors with mating right angle and straight shrouded headers. Assembly is made simpler due to our built-in interlocks on the modular housing types. Header housings are available in high-temperature resin for cost-effective reflow soldering process. Pre-assembled PCB terminal blocks are available upon request.

	Product	Pitch	AWG	Positions	Ratings	Advantage
	High Power Terminal Block	15	6-16	2-8	125A	High Power Terminal Block. One piece design, printed circuit board mount block on 15.0mm pin spacing, rated for up to 125 amps
	Front Style Terminal Block	5-5.08	14-24	2-12	16A	The key feature of the front style terminal block is that the wire entry cavity and the activating screw head are on the same plane which is parallel to the plugin direction. These plugs in particular are being released with 5.0mm and 5.08mm centerline spacing and will mate to industry standard vertical and right angle headers.
	Barrier Strip Style Terminal Blocks	0.250-0.4375 inch	10-30	2-30	30A	A barrier strip is designed for power applications and incorporates a flip-open clear safety cover. Barrier strips contain stray or frayed wire ends and prevent electrical shorts between positions on the same block, as well as adjacent component
	Push-In PCB TB Connectors	3.5-3.81	16-28	2-48	8A	Push-in clamp termination PCB connectors to provide for virtually tool - less wire insertion of ferruled and unferruled wires. Comparing this to a standard screw-clamp termination, installation labor time can be reduced by up to 80%,resulting in significant cost savings. The design of the PCB terminal blocks consists of two-piece plug connectors with mating straight and right-angle shrouded headers
		2.5	20-28	2-24	4A	

SOLDERLESS MOTOR SOLUTIONS

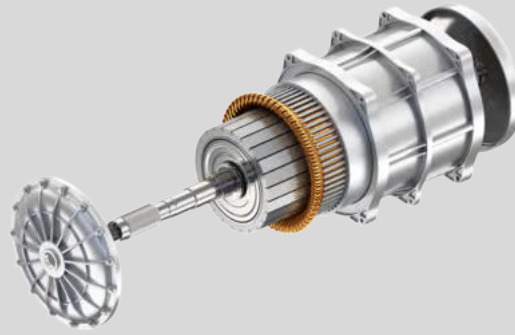

ELECTRIC BIKE



POWER TOOLS



HEAT COMPRESSOR

Learn more about our solderless magnet wire solutions and how they can help improve efficiency during electric motor manufacturing. These three case studies use the examples of electric bikes, power tools and heat compressors to show the versatility of solderless magnet wire terminals and splices.

[LEARN MORE ▶](#)

DESIGNING SUSTAINABLE CONNECTORS FOR HVAC COMPRESSORS

Explore this case study on sustainable cluster block solutions for enhanced safety and performance in heat compressor applications.

[READ ARTICLE ▶](#)

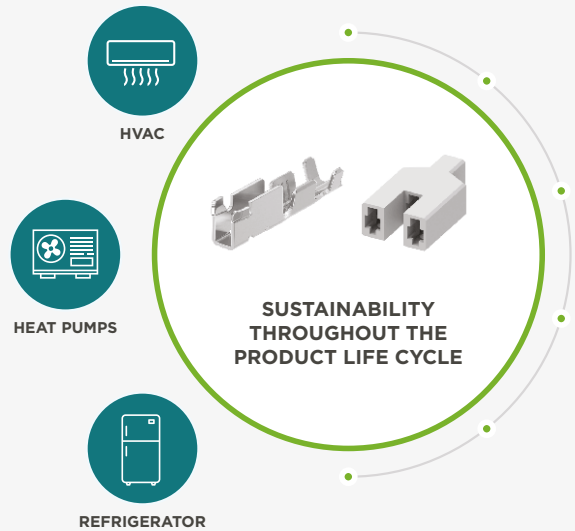

[te.com/hvac-solutions](https://www.te.com/hvac-solutions)

TE, TE Connectivity, TE connectivity (logo), AMPLIVAR, Axicom, ATUM, AMP DUOPLUG, AMP-LATCH, BUCHANAN, CERTI-CRIMP, GRACE INERTIA, SCHRACK, Potter & Brumfield, POWER TRIPLE LOCK, Power Versa-Lock, PRO-CRIMPER, AMP-O-LECTRIC, Positive Lock, AMP, AMP MONO-SHAPE, FASTON, PIDG, PLASTI-GRIP, FASTON, SOLISTRAND, TETRA-CRIMP, MTA, MAG-MATE, MATE-N-LOK, SIAMEZE, RAYCHEM and VAL-U-LOK are trademarks owned or licensed by the TE Connectivity Ltd. family of companies. Other product names, logos, and company names mentioned herein may be trademarks of their respective owners.

The information given herein, including drawings, illustrations and schematics which are intended for illustration purposes only, is believed to be reliable. However, TE Connectivity makes no warranties as to its accuracy or completeness and disclaims any liability in connection with its use. TE Connectivity's obligations shall only be as set forth in TE Connectivity's Standard Terms and Conditions of Sale for this product and in no case will TE Connectivity be liable for any incidental, indirect or consequential damages arising out of the sale, resale, use or misuse of the product. Users of TE Connectivity products should make their own evaluation to determine the suitability of each such product for the specific application. TE reserves the right to make any adjustments to the information contained herein at any time without notice.

© 2024 TE Connectivity. All Rights Reserved.

Published 08-24